

**USER AND  
MAINTENANCE  
MANUAL**



**TM 2 STROKE  
250 - 300 cc.**

**2012**

TM RACING  
USES and ADVICES





# IMPORTANT

YOU ARE ADVISED TO READ THIS MANUAL CAREFULLY BEFORE USING YOUR MOTO TM.  
IT CONTAINS A LOT OF INFORMATION AND ADVICE THAT WILL MAKE THE USE AND MAINTENANCE OF THE  
MOTORCYCLE MUCH EASIER AND SAFER.

IT IS IN YOUR SPECIFIC INTEREST TO PAY PARTICULAR ATTENTION TO THE WARNINGS INDICATED IN  
THE FOLLOWING WAY:



## **DANGER**

**FAILURE TO COMPLY WITH THESE WARNINGS RISKS LIVES!**



## **WARNING**

**FAILURE TO COMPLY WITH THESE WARNINGS COULD CAUSE DAMAGE TO PARTS OF THE MOTORCYCLE  
OR MAKE IT UNSAFE FOR USE.**

Please make note of your motorcycle's serial numbers in the boxes below.

When you must contact TM for spare parts, updating requests or to signal problems, indicate the model, cylinder capacity, year of  
manufacture and most of all the frame number and the engine serial number.

**FRAME NUMBER**

**ENGINE NUMBER**

**KEY NUMBER**

**STAMP OF THE AUTHORISED DEALER**

TM reserves the right to carry out changes without forewarning. The specifications can change from country to country.  
All indications are valid subject to spelling and printing errors.

## **Dear TM customer,**

We would like to congratulate you for having chosen a TM motorcycle.

Your TM is a competitive and modern motorcycle that will surely give you a lot of satisfaction if you treat it according to the provisions contained in this manual. **Before starting up your TM motorcycle for the first time, you must read this manual carefully so as to understand the regulations for use and the features of your new motorcycle.**

**Only in this way will you know how to adjust the motor cycle, and to adapt it in the best way possible to your personal characteristics and how to protect yourself from injury. This manual also contains important information regarding the maintenance of your new motorcycle.**

This manual is based on the most recent information concerning the product that was available on going to print. Further variations owing to successive constructive developments of the motorcycle are however possible. This manual is an integral part of the motorcycle, it must be given to the customer at the time of purchase and must remain with the motor cycle whenever it is re-sold.

Please note that the operations marked with (A) in the "Frame and Engine Maintenance" chapter must be carried out by a TM specialised workshop. If these maintenance operations should be necessary during competitions, they must be carried out by a qualified mechanic.

**For your safety, only use TM original spare parts and accessories. TM does not assume any responsibility for the use of other products and for damage deriving from them.**

We advise you to respect the running in period, inspection periods and established maintenance periods scrupulously. Only full compliance with these regulations will lengthen the life of your motorcycle. Overhauls and repairs must only be carried out by a specialised TM workshop.

For any information or requests contact a specialised TM workshop, which is backed by the TM importer. Please remember that a lot of technical data and information regarding TM motorcycles is available at: [www.tmracing.it](http://www.tmracing.it).

Motorcycling is a marvellous sport that you will be able to enjoy with your TM motorcycle. Always remember to respect the environment and other people. Always use the motorcycle with caution, it is in everybody's interest to safeguard the future of our sport.

Enjoy yourself with your TM motorcycle!

**TM RACING S.p.A.  
Via Fano 6 - 61122 PESARO  
ITALY**

TM RESERVES THE RIGHT TO CHANGE OR TO EXECUTE MODIFICATIONS AS IT DEEMS NECESSARY

# IMPORTANT ADVICE REGARDING THE LEGAL WARRANTY AND THE COMMERCIAL WARRANTY

TM sport motorcycles are designed and constructed in a manner to support the stress that may be verified in normal road and competition use.

Competition motorcycles are in compliance with the regulations of the categories actually in force at the most important international motorcycling federations.

The scrupulous compliance with the established inspections, maintenance and tuning of the engine and chassis part of the motorcycle, indicated in the user manual, is indispensable for correct functioning and to prevent premature wear of the parts of the motorcycle itself.

Incorrect tuning of the engine or of the chassis can also jeopardise one's own safety and that of others.

The maintenance operations established in the "Maintenance and Lubrication" table must be carried out by a specialised TM workshop at the envisioned dates, otherwise any warranty rights will be forfeited.

When you must contact your TM Dealer for spare parts, updating requests or to signal problems, indicate the model, cylinder capacity, year of manufacture and most of all the frame number and the engine serial number.

Fuels and lubricants must be those established in the user and maintenance manual and must be used as per maintenance programme. Products of other brands can be used as long as they have the equivalent specifications.

In cases of direct and consequent damage caused by tampering or modifications to the motorcycle, no legal warranty claim can be asserted.

The use of the motorcycle in extreme conditions, for example on muddy and very wet ground, may lead to greater than average wear of components, such as transmission components or the brakes. It is therefore possible that maintenance or replacement of some parts is necessary before the limit normally envisioned by the maintenance programme.

## **MX AND SMX MODELS CANNOT BE USED ON PUBLIC ROADS.**

The 250 and 300 models in the END, SMR and SMM versions can be used on roads only in the unvaried type-approved version (reduced). **Without this power limitation (i.e. reduced) these models can only be used off-the-road, but not on public roads.**

The END models have been designed for off-the-road resistance competitions (Enduro) and are not suitable for Motocross.

	Page		Page
<b>POSITION OF SERIAL NUMBER</b> .....	<b>7</b>	Adjustment of chain tension (all models except SMM) .....	43
Frame number .....	8	Adjustment of chain tension (SMM) .....	44
Engine number .....	8	Chain maintenance .....	44
<b>OPERATING CONTROLS</b> .....	<b>9</b>	Chain wear .....	45
Clutch lever BREMBO pump .....	10	Basic indications for TM disc brakes .....	45
Front brake lever NISSIN pump .....	10	Front brake NISSIN pump (END/MX) .....	46
Front brake lever BREMBO radial pump (SMR/SMM) .....	10	Front brake BREMBO radial pump (SMR/SMM) .....	47
Electronic digital tachometer (END) .....	11	Check front brake pads .....	47
Electronic digital tachometer (SMR/SMM) .....	11	Replacement of front brake pads .....	48
Engine stop switch (MX) .....	12	Modification of rear brake pedal base position .....	49
Combination switch (END) .....	12	Check rear brake fluid level .....	49
Handlebar switch (SMR/SMM) .....	13	Top-up rear brake fluid .....	49
Maps selection switch .....	13	Check rear brake pads .....	50
Ignition switch .....	14	Replacement of rear brake pads .....	50
Fuel filler cap .....	14	Disassembly and assembly of the front wheel .....	50
Fuel tap .....	14	Disassembly and assembly of the rear wheel (all except SMM) .....	51
Choke command (cold starter) .....	14	Disassembly and assembly of rear wheel (SMM) .....	52
Idle speed adjustment command .....	15	Check spoke tension .....	52
Gear shift pedal .....	15	Tyres, tyre pressure .....	53
Kickstart pedal .....	15	Check adjustment of magnetic sensor for tachometer .....	53
Brake pedal .....	15	Battery (SMR and SMM) .....	54
Side stand .....	16	Battery charge .....	54
Side stand fixing for off-road routes .....	16	Halogen light (END) .....	55
Fork adjustment in compression .....	16	Halogen light (SMR) .....	55
Fork adjustment in rebound .....	17	Ciclops headlight (SMM) .....	57
Shock absorber adjustment in compression .....	17	LED rear light (END) .....	58
Shock absorber adjustment in rebound .....	18	Rear light (SMR/SMM) .....	58
Steering lock .....	19	Direction indicator lamp (END/SMR/SMM) .....	58
<b>ADVICE AND GENERAL RECOMMENDATIONS FOR</b>		Cooling .....	59
<b>COMMISSIONING THE MOTORCYCLE</b> .....	<b>21</b>	Check coolant level .....	60
Indications for first start-up .....	22	Emptying, filling and bleeding of the cooling system .....	60
Running in instructions .....	22	Replacement of exhaust silencer packing material .....	60
<b>INSTRUCTIONS FOR USE</b> .....	<b>23</b>	Cleaning the air filter .....	61
Check before every start-up .....	24	Hydraulic clutch BREMBO pump .....	61
Cold engine start .....	25	Bleeding hydraulic clutch .....	62
If the engine is "flooded" .....	26	Throttle cable command adjustment .....	62
Bike starting .....	26	Notes on the carburettor .....	62
Shifting gear, accelerating, slowing down .....	26	Basic indications regarding carburetor wear .....	63
Braking .....	28	Check fuel level (float height) .....	64
Stopping and parking .....	28	Emptying the carburetor float bowl .....	64
Fuel .....	29	Check transmission oil level .....	65
<b>MAINTENANCE AND LUBRICATION TABLE</b> .....	<b>31</b>	Transmission oil .....	65
<b>FRAME AND ENGINE MAINTENANCE</b> .....	<b>37</b>	Change transmission oil .....	66
Check steering bearings and play adjustment .....	38	Inspection of the reed valve .....	66
Telescopic fork vent screws .....	39	<b>TROUBLESHOOTING</b> .....	<b>67</b>
Cleaning telescopic fork dust scraper .....	39	<b>CLEANING</b> .....	<b>69</b>
Basic calibration of the chassis on the basis of pilot weight .....	40	<b>PRECAUTIONS FOR WINTER USE</b> .....	<b>69</b>
Shock absorber calibration and spring check .....	40	<b>STORAGE</b> .....	<b>69</b>
Establishing rear shock static lowering .....	40	Start-up after seasonal pause .....	69
Establishing rear shock lowering in running order .....	41	<b>TECHNICAL DATA - ENGINE</b> .....	<b>70</b>
Check telescopic fork basic calibration .....	41	<b>CARBURETOR SETTINGS</b> .....	<b>72</b>
Variation of telescopic fork preload .....	41	<b>ENGINE TIGHTENING TORQUES</b> .....	<b>72</b>
Replacement of fork springs .....	42	<b>TECHNICAL DATA-CYCLE PART</b> .....	<b>73</b>
Variation of rear shock spring preload .....	42	<b>ALPHABETIC INDEX</b> .....	<b>74</b>
Rear suspension mechanical linkage .....	43	<b>WIRING DIAGRAM</b> .....	<b>appendix</b>
Check chain tension .....	43		

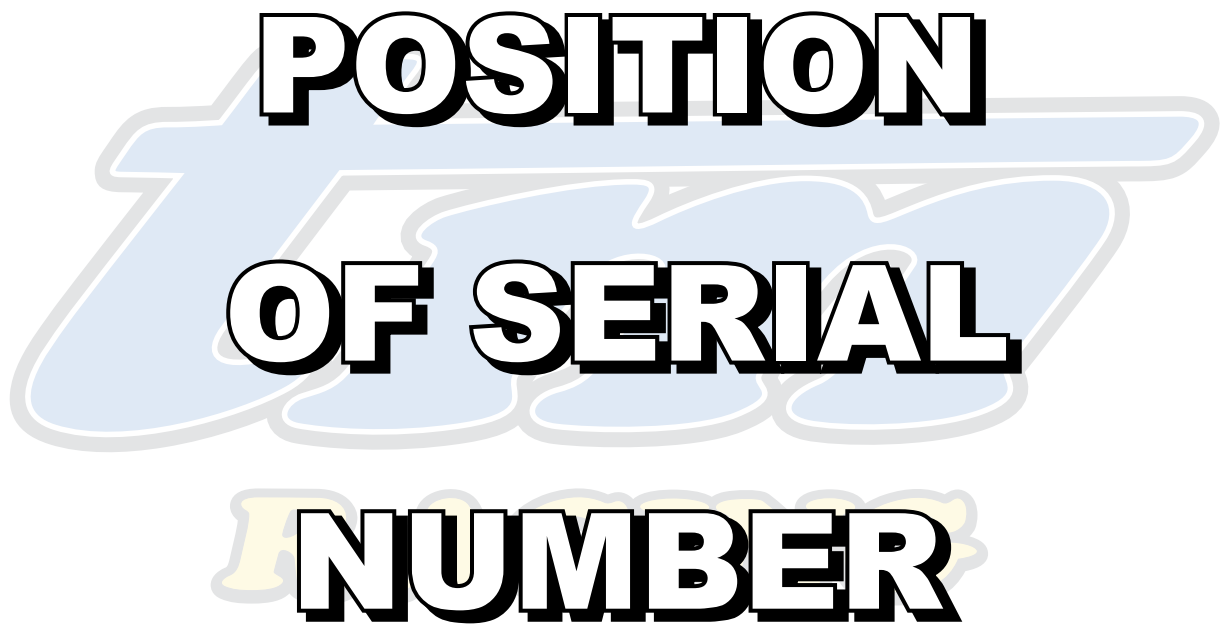

**POSITION  
OF SERIAL  
NUMBER**

## FRAME NUMBER

The frame number is embossed on the right side of the steering metal tube. Make note of this number in the appropriate space on page 3. In the END, SMR, SMM models, the serial number is also stated on a plate positioned on the left hand side. See photo.

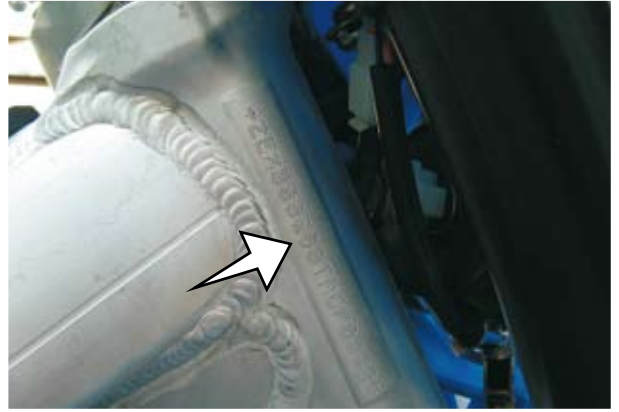

## ENGINE NUMBER

The engine number is engraved on the back side of the engine. Make note of this number in the appropriate space on page 3.

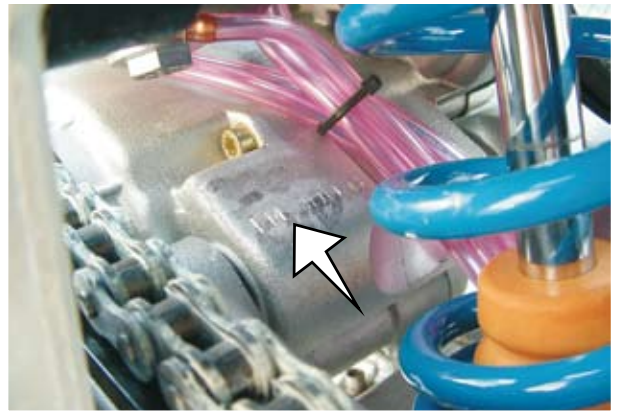





**OPERATING  
CONTROLS  
RACING**

**CLUTCH LEVER BREMBO PUMP**

The Brembo clutch pump is visible in the picture with n. 1  
 The clutch lever (2) is located on the left side of the handlebar.  
 With this option, to adjust the clutch lever distance from the handlebar grip (see maintenance operation), you have to turn the adjustment knob (3).  
 Rotate clockwise to increase the distance or counterclockwise to decrease the distance.

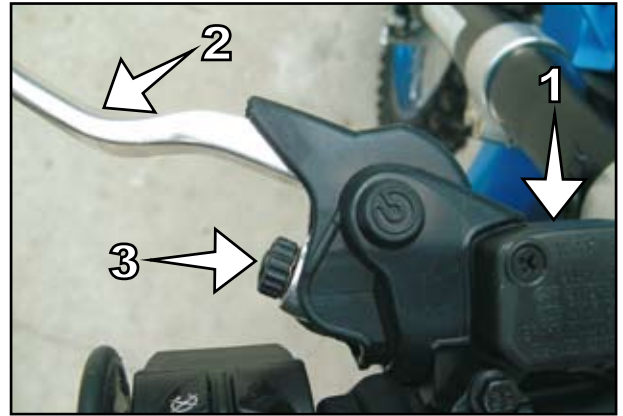
**FRONT BRAKE LEVER NISSIN PUMP (END/MX)**

The front brake pump lever (4) is located on the right side of the handlebar and activates the front wheel brake.  
 The distance of the front brak lever from the handlebar grip can be adjusted through the adjustment screw (5) (see "Frame and Engine Maintenance" chapter").

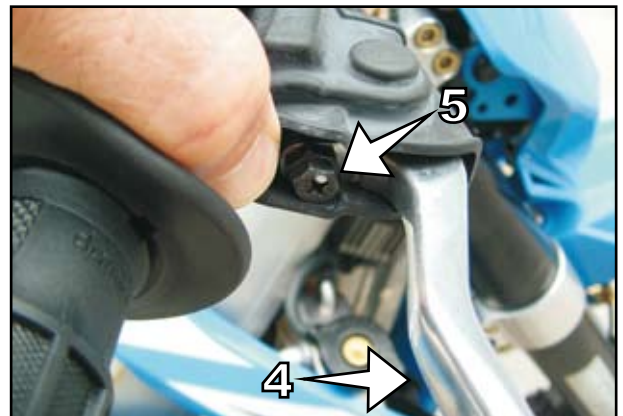
**FRONT BRAKE LEVER BREMBO RADIAL PUMP (SMR/SMM)**

The front brake pump lever (6) is located on the right side of the handlebar and activates the front wheel brake. The distance of the brake lever from the handlebar grip can be adjusted through the adjustment knob (7) (see "Frame and Engine Maintenance" chapter)



## ELECTRONIC DIGITAL TACHOMETER (END)

See n.1 in the picture. It has a large backlit display and four pilot lights.

On the LH side, in the top there is the high beam pilot light (2), in the centre there is the neutral pilot light (3) not used, in the bottom there is the ADJUST button (4).

On the RH side, in the top there is the indicator pilot light (5), in the centre there is the low beam pilot light (6), in the bottom the SELECT button (7).

In the display you can find the digital speed indicator (tachometer) (8), the trip odometer TRIP (9) or the total odometer ODO (10).

To switch from TRIP to ODO display, press briefly the ADJUST button once. Repeat the operation to switch from ODO to TRIP.

The instrument unit is the Km/h but you can set it in Mph in the following way: press both ADJUST and SELECT buttons for 3 seconds. The measurement unit will blink. Press ADJUST button to switch from Km/h to Mph and viceversa.

Press briefly the SELECT button 7 times to complete the new setting and come back to the initial screen.

The trip odometer can be reset by holding pressed the "SET" button once for 5 seconds.

The total kilometres odometer resets automatically when reaching the limit of 99999 Km or Miles.

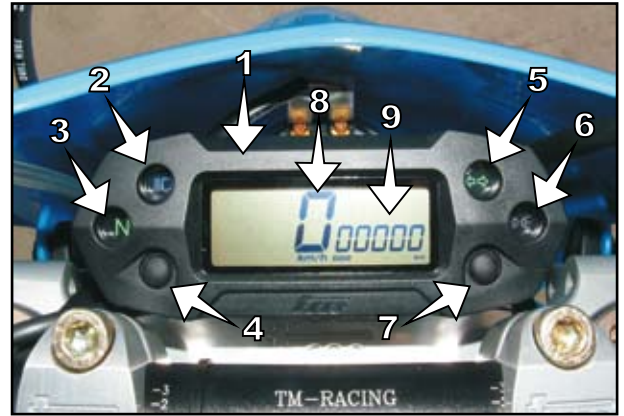

## ELECTRONIC DIGITAL TACHOMETER (SMR/SMM)

See n. 10 in the picture. It has a wide backlit display and four pilot lights.

In the top there are the left indicator pilot light (11), the low beam pilot light (12), the high beam pilot light (13) and the right indicator pilot light (14).

Inside the display you find the tachometer (15), the trip odometer (16) and the total kilometers odometer (17).

In the bottom there are two buttons, "SET" (18) and "MODE" (19).

The instrument unit is the Km/h but it can be easily changed in Mph in the following way: press and hold the "SET" button, while holding it press once the "MODE" button.

Repeat the same operation to switch back to Km/h.

The trip odometer can be reset by holding pressed the "SET" button once for 4 seconds.

The total kilometres odometer resets automatically when reaching the limit of 99999 Km or Miles.

The SMR and SMM models (END on request) are supplied with a separate battery for using the speedometer while the engine is OFF. This is under the saddle.



**ENGINE STOP SWITCH (MX)**

The engine stop switch is found near the clutch pump.  
The engine is shutdown using the engine stop switch (20): when it is activated a shortcircuit is caused in the ignition, which no longer supplies voltage to the spark plug.  
Press the button until the engine switches off and then release.

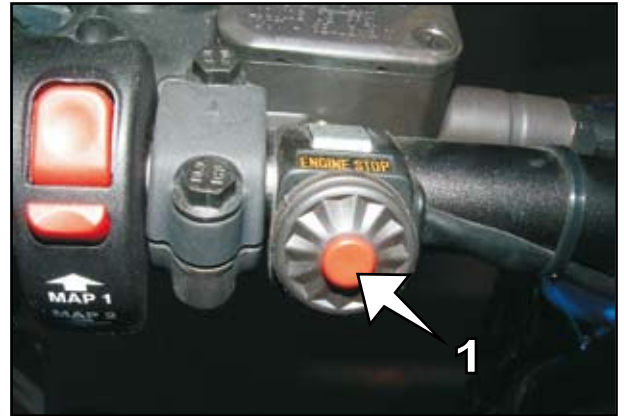

**COMBINATION SWITCH (END)**

This command is located near the handlebar left grip. See n. 1 in the picture.  
The use of the switch is very easy.  
When the symbol (4) on the rotating ring (3) is aligned with the symbol (5) on the switch body, lights are switched off.  
To switch the lights on, turn the ring (3) counterclockwise until the symbol (6) is aligned with the symbol (5).  
Operate in the same way to switch on the high beam (7) and the low beam (8).  
Press the button (9) to activate the horn.  
Press the rocker switch (10) on the left to activate the left hand indicator and on the right to activate the right hand indicator.  
Press button (11) to switch off the engine.

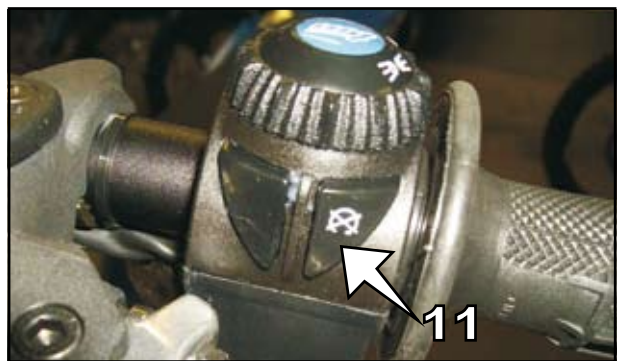
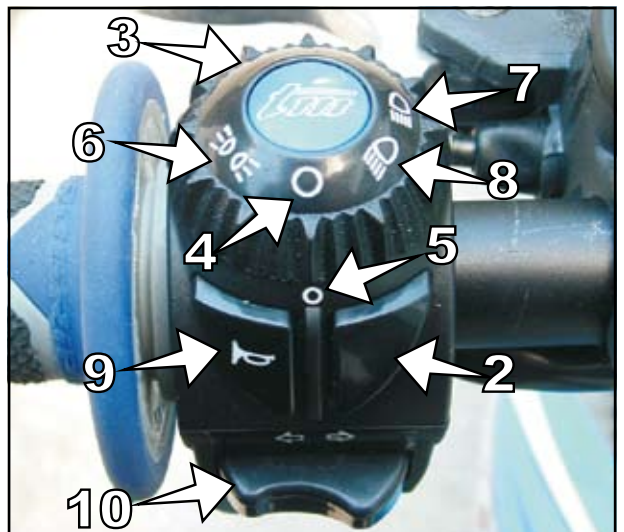

**HANDLEBAR SWITCH (END)**

This command is located near the the handlebar left grip. See n. 1 in the picture. The use of the handlebar switch is normal and simple. The button (2) activates the horn, the button (3) if pressed towards left, activates the LH indicator, if pressed towards right, activates the RH indicator. If pressed straight in the middle it deactivates the indicator. The slider (4) allows you to select between lights off, position lights on, low beam on. The red button (5) switches between low beam and high beam. By pressing the button (6) you turn on the high beam for flashing.

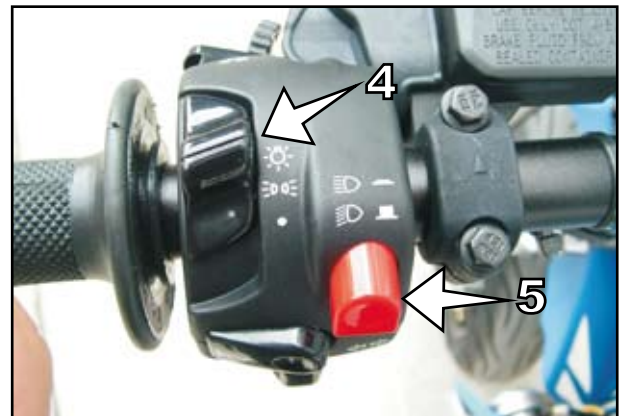
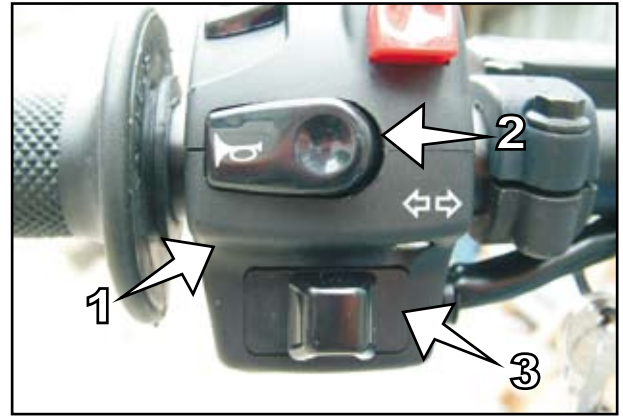

**MAPS SELECTION SWITCH**

Some models are equipped with a central control unit with double mapping that can be selected using the button positioned on the left side of the handlebar. Map 1 corresponds to an aggressive map, Map 2 to a soft map.



**IGNITION SWITCH**

In the SMR and SMM models a lock (1) for the ignition key is added on the left side of the dashboard.  
 By turning the key clockwise, the electric circuit is closed and you can press the kickstart pedal up the engine.  
 Turn the key anticlockwise to turn off the engine.  
 Before leaving the bike extract the key from the lock.

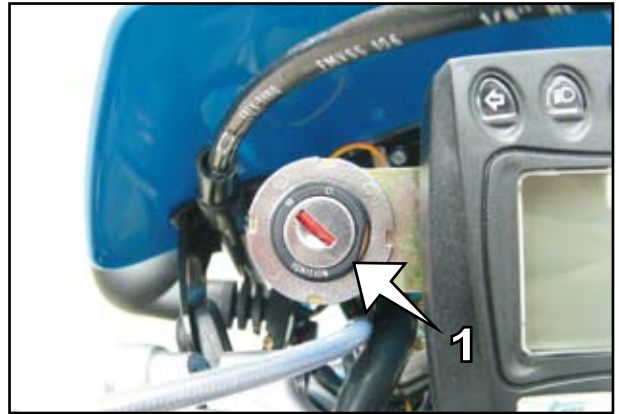

**FUEL FILLER CAP**

The fuel fill cap is found on top of the tank.  
**Open:** turn the cap in an anti-clockwise direction  
**Close:** place the cap on the inlet well and tighten it in a clockwise direction.

Position the tank's open vent pipe (2) preventing bends or crushing and making sure that it is inserted correctly.



**FUEL TAP**

The tap (3) is located on the left hand side of the tank base.  
**OFF** On the OFF position, the fuel tap is closed.  
**ON** On the ON position, the fuel tap is open.  
 When the motorcycle is used, turn the tap to the ON position. In this way the fuel flows to the carburetor and the tank empties up to reserve.  
**RES** On the RES position, the reserve is used. After having filled up the tank, do not forget to move the tap back to the ON position.

Tank capacity (all models): ..... lt. 10 (incl. reserve 1 lt.)



**CHOKE COMMAND (COLD STARTER)**

This command is located on the carburetor.  
**For KEIHIN carburetors**  
 By fully extracting the choke knob (4), a passage is opened in the carburetor, through which the engine can suck additional fuel. In this way, a "rich" air-fuel mix is obtained. This is necessary for starting the engine when it is cold.  
 To disconnect the command, push the choke knob inwards to its original position.



**IDLE SPEED ADJUSTMENT COMMAND**

This control is on the left-hand side of the carburettor for both models. Turning the idle screw (2) increases or decreases the engine's idling speed.

Turn it clockwise to increase the idling speed or anticlockwise to decrease it.

The idling speed, with the engine warm, must be between 1,400 and 1,600 rpm.

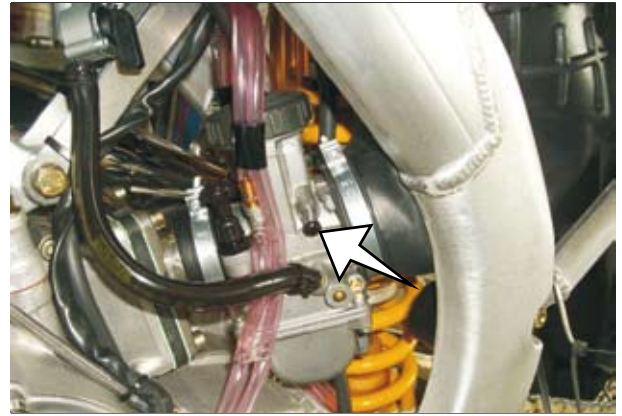
**GEAR SHIFT PEDAL**

The gear shift pedal is positioned on the engine left side. The position of the gears is indicated in the illustration. The neutral is between the first and second gears.

To select the first gear, pull the clutch lever and press the gear shift pedal downwards.

To select the other speed pull the clutch lever and pull the gear shift pedal upwards.

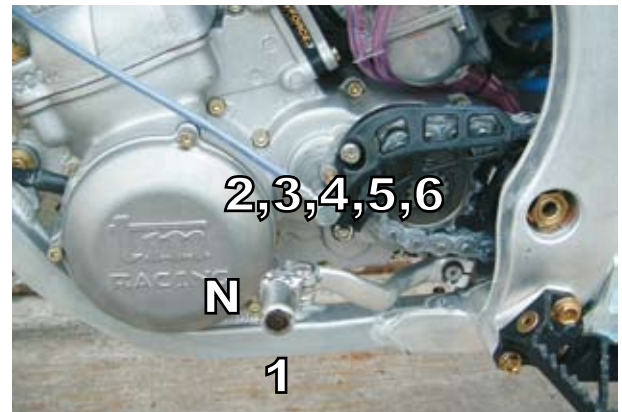
**KICKSTART PEDAL**

The kickstart pedal is positioned on the right side of the engine. The upper part is turned outwards to start-up the engine and replaced inside as soon as the engine is running.

**BRAKE PEDAL**

The brake pedal is positioned in front of the right foot rest. The basic position can be adjusted according to the rider's preference (see maintenance operations).



## SIDE STAND

Push the side stand to the floor using the foot and rest the motorcycle on it. Pay attention that the ground is solid and the position stable.



## SIDE STAND FIXING FOR OFFROAD ROUTES

If you drive the motorcycle off-road, the closed side stand can be additionally fixed using a rubber band (1).



## FORK COMPRESSION ADJUSTMENT

The hydraulic brake system determines the behaviour of the fork in the in compression stroke. The degree of hydraulic dampening in compression can be adjusted on the basis of pilot preferences and/or hardness of the spring installed.

### MARZOCCHI USD FORK

There is an adjusting screw (2) on the fork cover. Operate using a screwdriver. Turning the screw clockwise the dampening increases, turning it anticlockwise the dampening decreases. A total of 28 clicks **Never turn the side screw (3).**

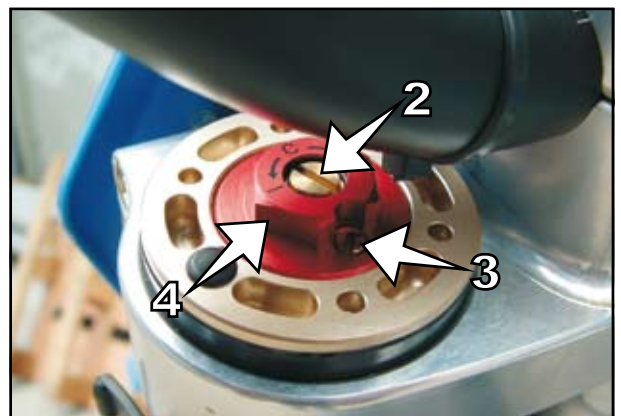

**⚠ WARNING**  
DO NOT OPERATE ON THE RED HEXAGONAL NUT (4) BECAUSE IT DOES NOT CHANGE THE SPRING PRELOAD.

**⚠ WARNING**  
BEFORE STARTING IT IS ADVISED TO TIGHTEN THE ADJUSTER FROM THE STANDARD POSITION TO THE "TOTALLY CLOSED" POSITION AND COUNT THE NOTCHES DETECTED SO THAT THE STANDARD POSITION CAN BE RESTORED. FOR CONVENTION, THE NOTCHES ARE INDICATED FROM THE "TOTALLY CLOSED" POSITION.  
BOTH LEGS MUST HAVE THE SAME ADJUSTMENT.



**FORK REBOUND ADJUSTMENT**

The hydraulic dampening in extension determines the behaviour of the fork in the rebound stroke.

The degree of dampening in rebound can be adjusted on the basis of rider preferences and/or hardness of the spring installed.

**MARZOCCHI USD FORK**

The adjustment screw (1) is located in the lower part of the fork leg. For this operation, use a screwdriver. By turning the screw clockwise, dampening increases, while turning it anticlockwise, dampening decreases. A total of 28 clicks are available.

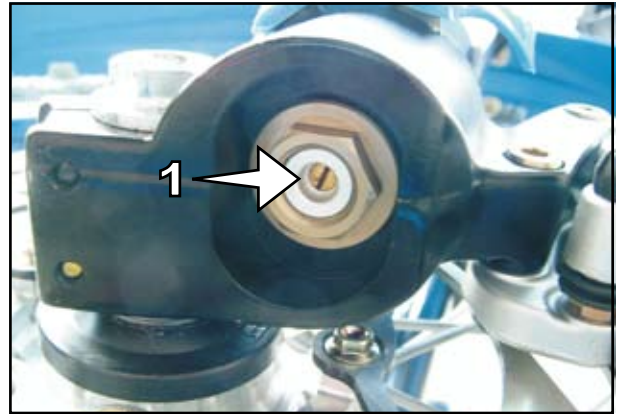
**⚠ WARNING**

BEFORE STARTING IT IS ADVISED TO TIGHTEN THE ADJUSTER FROM THE STANDARD POSITION TO THE "TOTALLY CLOSED" POSITION AND COUNT THE CLICKS DETECTED SO THAT THE STANDARD POSITION CAN BE RESTORED.

FOR CONVENTION, THE NUMBER OF CLICKS IS INDICATED FROM THE "TOTALLY CLOSED" POSITION.

BOTH LEGS MUST HAVE THE SAME ADJUSTMENT.

**⚠ WARNING**

FOR FURTHER AND MORE DETAILED INFORMATION REGARDING THE FORK, BOTH STANDARD AND OPTIONAL, REFER TO THE "OWNERS MANUAL" SUPPLIED BY THE MANUFACTURER OF THE FORK SUPPLIED BY TM ACCOMPANYING THE MOTORCYCLE.

**SHOCK ABSORBER COMPRESSION ADJUSTMENT**

The hydraulic dampening in compression determines the behaviour of the shock absorber in the compression stroke. The degree of dampening in compression can be adjusted on the basis of pilot preferences and/or hardness of the spring installed.

Both standard and optional shock absorbers mounted on the TM offer the possibility of double adjustment in compression for low and high speeds.

Low and high speeds mean the movement speed of the damper in compression and not the speed of the motorcycle.

**SACHS SHOCK ABSORBER (STANDARD)**

Low speeds- The adjustment screw (3) is located on the top of the damper gas tank. Use a screwdriver. By turning the screw clockwise, dampening increases, anticlockwise dampening decreases. A total of 24 clicks are available.

High speeds - The adjuster is a knob (4) and is concentric to the low speed adjustment screw. Operate manually. By turning the knob clockwise, dampening increases, anticlockwise dampening decreases. A total of 20 clicks are available.



**OHLINS SHOCK ABSORBER (OPTIONAL)**

**Low speed**- The adjustment screw (1) is on the top of the damper gas tank. Use a screwdriver. By turning the screw clockwise, dampening increases, anticlockwise dampening decreases. A total of 25 clicks are available.

**High speed**- The adjuster is a hexagonal ring nut (2) and is concentric to the low speeds adjustment screw. Use a 17mm hexagonal spanner. By turning the nut clockwise, dampening increases, anticlockwise dampening decreases. A total of 4 clicks are available.

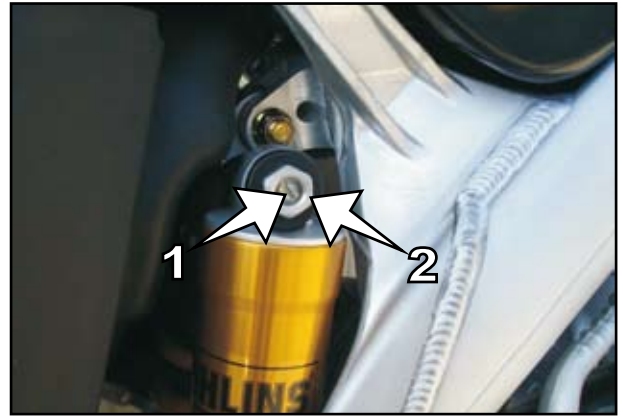
**TM SHOCK ABSORBER (OPTIONAL)**

**Low speed** - The setting screw (3) is located on the top of the damper gas tank. Use a screwdriver. By turning the screw clockwise, dampening increases, anticlockwise dampening decreases. A total of 24 clicks are available.

**High speed** - The adjuster is an hexagonal ring nut (4) and is concentric to the low speeds adjustment screw. Use a 14mm hexagonal wrench. By turning the nut clockwise, dampening increases, anticlockwise dampening decreases. A total of 28 clicks are available.

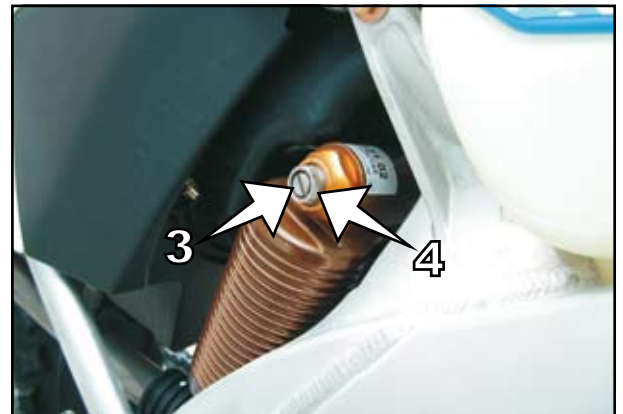
**⚠ WARNING**

BEFORE STARTING IT IS ADVISED TO TIGHTEN THE ADJUSTER FROM THE STANDARD POSITION TO THE "TOTALLY CLOSED" POSITION AND COUNT THE CLICKS/TURNS DETECTED SO THAT THE STANDARD POSITION CAN BE RESTORED.

FOR CONVENTION, THE NUMBER OF CLICKS/TURNS ARE INDICATED FROM THE "TOTALLY CLOSED" POSITION.

**SHOCK ABSORBER REBOUND ADJUSTMENT**

The hydraulic brake system in rebound determines the behaviour of the shock absorber in rebound stroke. The degree of hydraulic braking in rebound can be adjusted on the basis of rider preferences and/or hardness of the spring installed.

**SACHS SHOCK ABSORBER (STANDARD)**

The adjustment screw (5) is situated on the fork of the shock absorber (side of mechanical linkage). Use a screwdriver. By turning clockwise, braking increases, anticlockwise it decreases. A total of 40 clicks are available.



## OHLINS SHOCK ABSORBER (OPTIONAL)

The adjustment knob (1) is located low at the end of the damper rod. Operate manually. By turning clockwise (looking from the bottom upwards) braking increases, anticlockwise, it decreases. A total of 40 clicks are available.

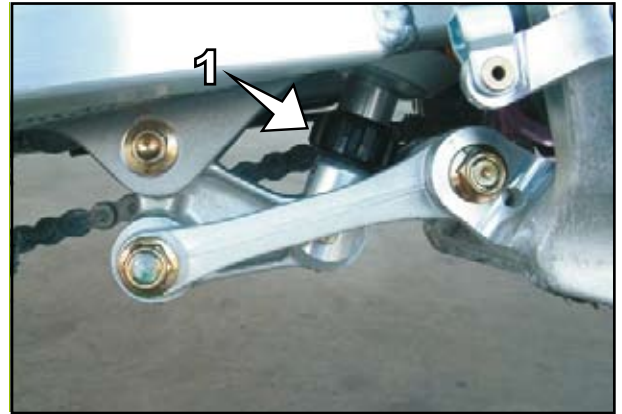

## TM SHOCK ABSORBER (OPTIONAL)

The setting screw (2) is located on the lower end of the shock. Use a screwdriver to turn the screw clockwise if you want to increase the dampening or anticlockwise if you want to reduce the dampening. A total of 27 clicks is available.

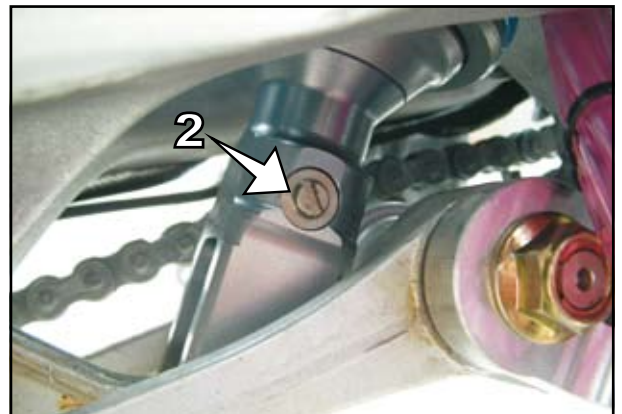

### **WARNING**

BEFORE STARTING IT IS ADVISED TO TIGHTEN THE ADJUSTER FROM THE STANDARD POSITION TO THE "TOTALLY CLOSED" POSITION AND COUNT THE CLICKS DETECTED SO THAT THE STANDARD POSITION CAN BE RESTORED.

FOR CONVENTION, THE NUMBER OF CLICKS IS INDICATED FROM THE "TOTALLY CLOSED" POSITION.

### **DANGER**

THE DAMPER GAS TANK IS FILLED WITH PRESSURISED NITROGEN . NEVER TRY TO DISASSEMBLE THE DAMPER OR CARRY OUT MAINTENANCE OPERATIONS WITHOUT THE HELP OF TECHNICIANS, OTHERWISE PARTS COULD BE DAMAGED AND PERSONS INJURED

## STEERING LOCK

This lock is situated on the left side of the frame steering tube. This lock stops rotation of the handlebar, preventing the motorcycle being driven.

To lock the steering, turn the handlebar completely to the right, insert the key, turn it to the left, press, turn to the right and extract.

### **WARNING**

NEVER LEAVE THE KEY IN THE LOCK. BY TURNING THE HANDLEBAR TO THE LEFT, THE KEY COULD BE DAMAGED.

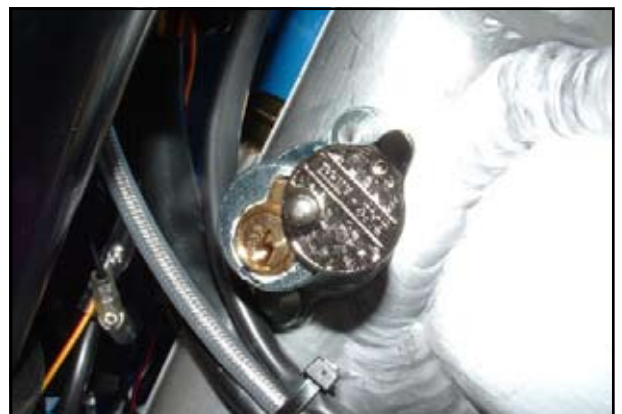



**ADVICE AND  
GENERAL  
RECOMMENDATIONS  
FOR COMMISSIONING  
THE MOTORCYCLE**



# ADVICE AND GENERAL RECOMMENDATIONS FOR COMMISSIONING THE MOTORCYCLE

## INDICATIONS FOR FIRST START-UP

- Ensure that the "PRE-DELIVERY OPERATIONS" of your motorcycle have been carried out by your TM dealer.
- Carefully read all user instructions before making the first journey.
- Become familiar with all operating controls.
- Adjust the clutch lever, the front brake lever and the brake pedal so that they are in the most comfortable position.
- Get used to driving in an empty carpark or on land where it is easy to handle the motorcycle before making a long journey. Also try to move at a slow pace on foot to get used to the motorcycle.
- Do not take routes that are too difficult for your driving ability and experience.
- On the road, hold the handlebar with both hands and leave your feet on the footrests.
- Be careful not to push the brake pedal if you do not wish to brake. If the brake pedal is not released, the brake pads rub continuously and the brake overheats.
- Do not modify the motorcycle and always use ORIGINAL TM SPARE PARTS. Spare parts made by other manufacturers can jeopardise the safety of the motorcycle.
- Motorcycles are sensitive to the movement of weight. When carrying luggage, fix it as near as possible to the centre of the motorcycle and distribute the weight equally between the front and rear wheel.
- Follow running in instructions.

## RUNNING IN INSTRUCTIONS

The surfaces of components of a new motorcycle, even if they undergo precision workings, are however less smooth than the same components in a motorcycle that have been driven for a time: this explains the necessity for running in the new engine.

To obtain an optimal bedding of the moving parts of a new engine, it must be taken to produce maximum performance gradually.

For this reason, during the first 3 hours of use (1 hour for competition use) the engine must only be used up to max. 50% of its power. Moreover, the number of revs. must not exceed 7000/min.

In the following 5 hours of use (1 hour for competition use) the engine can be used up to max. 75% of its power. Drive the motorcycle in different conditions (road, easy off-road tracts). Do not make long journeys without ever closing the throttle.

By following these regulations, you will obtain maximum performance and longer duration of the motorcycle through time.

## WARNING

THE 250 and 300 END/MX MODELS HAVE BEEN DEVELOPED WITH NO COMPROMISE FOR OFF-ROAD COMPETITIONS. EVEN IF THE ENDURO MODELS ARE TYPE-APPROVED, PAY ATTENTION WHEN USING ON THE ROAD. MOST OF ALL AVOID TO RIDE FULL THROTTLE FOR A LONG TIME.

## DANGER

- ALWAYS WEAR SUITABLE CLOTHING WHEN USING THE MOTORCYCLE. ASTUTE MOTORCYCLISTS THAT DRIVE A TM ALWAYS WEAR THE TYPE-APPROVED HELMET, BOOTS, GLOVES AND A JACKET, WHETHER IT IS A LONG OR SHORT JOURNEY. THE PROTECTIVE CLOTHING SHOULD BE BRIGHT SO THAT THE MOTORCYCLIST CAN BE EASILY SEEN BY OTHER ROAD USERS.
- ALWAYS SWITCH THE HEADLIGHT ON DURING THE JOURNEY, SO THAT OTHER ROAD-USERS CAN SEE YOU IN TIME.
- DO NOT DRINK AND DRIVE.
- ONLY USE ORIGINAL TM ACCESSORIES. FRONT COVERINGS, FOR EXAMPLE, CAN NEGATIVELY AFFECT THE BEHAVIOUR OF THE MOTORCYCLE ON THE ROAD AT HIGH SPEEDS, OR HAVE NEGATIVE INFLUENCE OF THE BEHAVIOUR OF THE MOTORCYCLE DUE TO DIFFERENT WEIGHT DISTRIBUTION.
- THE FRONT AND REAR TYRES MUST HAVE THE SAME TYPE OF PROFILE.
- AFTER THE FIRST 30 MINS, OF DRIVING, THE WHEEL SPOKE TENSION MUST BE CHECKED. SPOKE TENSION DECREASES QUICKLY ON NEW WHEELS. IF YOU DRIVE WITH LOOSE SPOKES, THE SPOKES MAY BREAK, CAUSING UNSTABLE DRIVING CONDITIONS (SEE CHECK SPOKE TENSION).
- THE RACING MODELS HAVE BEEN DESIGNED AND PREPARED ONLY FOR ONE PERSON. IT IS PROHIBITED TO TAKE ON PASSENGERS.
- FOLLOW THE HIGHWAY CODE, DRIVE CAREFULLY SO AS TO RECOGNISE DANGERS AS SOON AS POSSIBLE.
- ADAPT SPEED TO THE CONDITIONS OF THE ROAD AND YOUR DRIVING CAPABILITY.
- DRIVE CAREFULLY ON UNKNOWN ROADS OR LAND.
- WHEN OFF-ROAD YOU SHOULD ALWAYS BE ACCOMPANIED BY A FRIEND WITH A SECOND MOTORCYCLE, SO THAT YOU CAN HELP EACH OTHER IF DIFFICULTIES OCCUR.
- IN DUE TIME, REPLACE THE VISOR OR LENSES OF THE GOGGLES. YOU WILL BE BLINDED AGAINST SUNLIGHT IF THE VISOR OR GOGGLES ARE SCRATCHED.
- DO NOT LEAVE THE MOTORCYCLE UNSUPERVISED IF THE ENGINE IS RUNNING.

## DANGER

- MX MODELS ARE NOT TYPE-APPROVED FOR USE ON PUBLIC ROADS OR MOTORWAYS.
- WHEN USING YOUR MOTORCYCLE, ALWAYS KEEP IN MIND THAT EXCESSIVE NOISE DISTURBS OTHERS.



**INSTRUCTIONS**

**FOR USE**



**CHECK BEFORE EVERY START-UP**

To use the motorcycle safely, it must be in a good shape. It is a good idea to carry out a general check-up of the motorcycle before every start-up.

This check must include the following operations:

**1 TRANSMISSION OIL LEVEL**

To ensure adequate lubrication, the level of the oil in the engine must be kept within the envisioned limits. Using the engine with the oil level below minimum leads to premature wear and successively, to damage and risks to the driver.

**2 FUEL**

If the motorcycle does not have a transparent tank, open the tank cap and visually check the quantity of fuel contained in the tank. Re-close the tank, making sure that the open vent pipe is not bent and so impeding the flow of air.

**3 CHAIN**

The drive chain must always be tensioned correctly and well lubricated.

A loose chain knocks and may escape from the sprockets.

A too tight chain wears early and may cause wear and breakage of some important transmission components.

**4 TIRES**

Check for any damage. Tyres with cuts or swellings must be replaced immediately.

Check the depth of the tread which must correspond to the law.

Finally, check the air pressure and take it to the values envisioned in the table, if necessary.

Worn tread and unsuitable air pressure worsen driving of the motorcycle and may cause loss of control and serious accidents.

**5 BRAKES**

Verify correct operation.

Check the level of brake fluid. The reservoir on the pumps are dimensioned in a way that in case of normally worn brake pads the fluid does not need to be topped-up. If the level of brake fluid falls below the minimum level, this indicates a leak in the brake system or complete consumption of the brake pads. Have the brake system checked by a specialised TM workshop, given that in this case the brakes could fail.

The state of the brake's flexible pipes and the thickness of the pads must also be checked.

Check the free play and the smoothness of the front brake lever and the rear brake pedal.

**6 FLEXIBLE CABLE COMMANDS**

Check the adjustment and correct working of all flexible cable commands.

**7 COOLANT**

Check the level of coolant with cold engine. Top-up with the liquid stated in the table, if necessary.

**8 ELECTRICAL PLANT**

With the engine running, check for the front headlight, the front and rear position lights, the rear braking light, the direction indicator lights, the control lights and the horn.

**9 LUGGAGE**

Check that any luggage is well fixed.

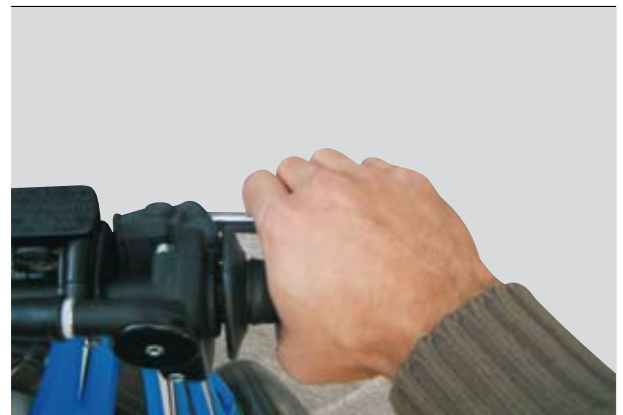



**COLD ENGINE START**

- 1 Open the fuel tap (1).
- 2 Remove the motorcycle from the stand.
- 3 Put the gears in neutral.
- 4 Activate the choke command (2), which is located on the left side of the carburetor.
- 5 WITHOUT opening the throttle, press hardy the kickstarter DOWN TO THE BOTTOM once or twice, or operate the electric starter.
- 6 Start to warm the engine by accelerating slightly for about 30 secs. Disconnect the choke (2), which is situated on the left side of the carburetor.

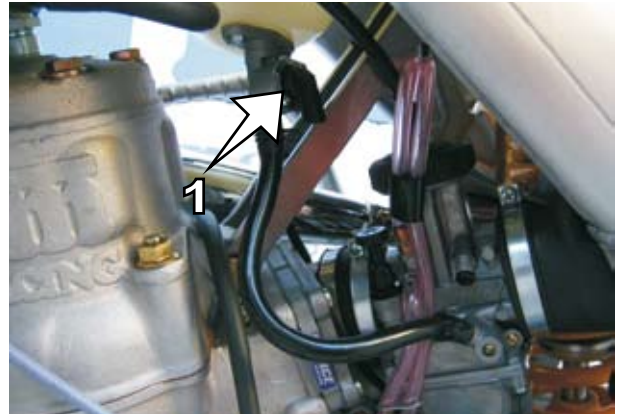
**⚠ DANGER**

- ALWAYS WEAR STRONG MOTORCYCLE BOOTS WHEN STARTING UP THE MOTORCYCLE TO PREVENT INJURY. YOU COULD SLIP OFF OF THE PEDAL OR THE ENGINE COULD KICKBACK AND MAKE YOU KNOCK YOUR FOOT VIOLENTLY.
- ALWAYS PRESS THE KICKSTARTER DOWN HARD WITHOUT ACCELERATING. KICKSTARTING WITH LITTLE FORCE OR WITH OPENED THROTTLE, INCREASES THE RISK OF ENGINE KICK BACK.
- DO NOT START THE ENGINE IN A CLOSED SPACE AND NEVER LEAVE IT RUNNING IN CLOSED SPACES. THE EXHAUST FUMES ARE POISONOUS AND MAY LEAD TO RISK OF UNCONSCIOUSNESS AND DEATH. WHEN THE ENGINE IS RUNNING, ALWAYS ENSURE THERE IS SUFFICIENT VENTILATION.
- ALWAYS CHECK THAT THE GEAR IS IN NEUTRAL BEFORE OPERATING THE KICKSTARTER PEDAL. IF A GEAR IS INSERTED WHEN STARTING THE ENGINE, THE MOTORCYCLE WILL JUMP FORWARDS.

**⚠ WARNING**

- DO NOT ALLOW THE ENGINE REVS. TO INCREASE TOO MUCH WHILE THE ENGINE IS COLD. THIS COULD DAMAGE THE ENGINE BECAUSE THE PISTON HEATS UP AND CONSEQUENTLY, IT EXPANDS QUICKER THAN THE CYLINDER, WHICH IS WATER-COOLED. ALWAYS WARM THE ENGINE AT A STANDSTILL OR MOVE AT LOW REVS.

**IF THE ENGINE IS “FLOODED”**

In the event of a fall, a certain amount of fuel can flow out the carburetor and enter the cylinder, “flooding” the engine.

To start the engine, pull out the plug cap assy , unscrew the spark plug and extract it, then press the kick start pedal several times firmly DOWN TO THE BOTTOM.

Check that the electrodes on the spark plug are not wet with fuel and dry if they are. Put the spark plug back in, screwing it back down carefully. Try the kick start pedal again.

**BIKE STARTING**

Pull the clutch lever, insert the first gear, release the clutch lever slowly, accelerating at the same time.

**⚠ DANGER**

**BEFORE STARTING, ALWAYS CHECK THAT THE SIDE STAND HAS BEEN LIFTED. IF THE STAND SLIDES ALONG THE GROUND YOU COULD LOOSE THE CONTROL OF THE MOTORCYCLE.**

**SHIFTING GEAR, ACCELERATING, SLOWING DOWN**

1<sup>st</sup> gear, which should be selected, is the pulling away and ascent gear. If the circumstances permit (speed limits, traffic, slopes), to increase speed, insert higher gears. To do this, close the throttle, pull the clutch lever at the same time, insert the successive gear, release the clutch and accelerate up to 1/2 turn of the throttle. Then insert the following gear and repeat this operation until the desired speed is reached and however, permitted by the limits in force.

Gradual opening of the accelerator allows a careful driving and limits consumption. Learn the correct opening of the throttle on the basis of the pace at which you want the motorcycle to move.

To reduce speed, the throttle must be closed. Brake and shift down the gears, pulling the clutch lever and inserting a lower gear. Release the clutch slowly and accelerate or change gear again . Always increase or change down the gears one at a time!

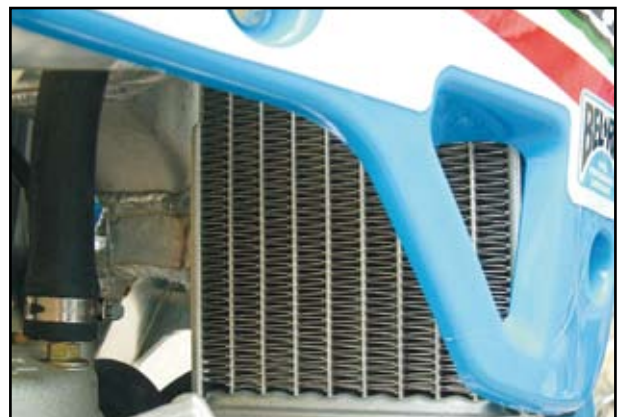

**INDICATION:**

All TM models do not have a radiator cooling fan and the radiator dimensions have been studied to optimise compactness and weight. The cooling system is sufficient for touristic or sports use.

If you want to use an additional cooling fan contact a TM authorised dealer.

- **TM MODELS CAN BE RE-STARTED AT ANY TIME BY KICK STARTER. SWITCH THE ENGINE OFF WHEN YOU INTEND TO KEEP THE MOTORCYCLE AT A STANDSTILL FOR MORE THAN 2 MINUTES.**

** DANGER**

- **AFTER EVERY FALL, THE MOTORCYCLE MUST BE CONTROLLED IN THE SAME WAY AS BEFORE EVERY START-UP .**
- **A DEFORMED HANDLEBAR MUST ALWAYS BE REPLACED. NEVER STRAIGHTEN THE HANDLEBAR AS IT COULD LOOSE ITS STRENGTH.**

** WARNING**

- USE OF THE ENGINE AT A HIGH NUMBER OF REVS WHEN IT IS COLD, NEGATIVELY AFFECTS THE DURATION OF THE ENGINE. BEFORE USING THE MOTORCYCLE AT FULL WORKING CONDITIONS, IT IS BETTER TO WARM IT ADEQUATELY BY DRIVING AT AN AVERAGE SPEED. THE ENGINE HAS REACHED ITS WORKING TEMPERATURE AS SOON AS THE RADIATORS BECOME HOT.
- NEVER SHIFT DOWN A GEAR WITHOUT HAVING FIRST SLOWED DOWN. THE ENGINE WOULD BE TAKEN TO AN EXCESSIVE NUMBER OF REVS AND THE VALVES AND OTHER ENGINE COMPONENTS WOULD BE DAMAGED. THE REAR WHEEL COULD ALSO LOCK, LEADING TO LOSS OF CONTROL OF THE VEHICLE.
- IF THERE ARE ABNORMAL VIBRATIONS DURING FUNCTIONING, CHECK THAT THE SCREW FASTENERS ARE TIGHTENED WELL.
- IF STRANGE NOISES ARE HEARD DURING DRIVING, STOP IMMEDIATELY, SWITCH THE ENGINE OFF AND CONTACT A TM AUTHORISED DEALER.

## **BRAKING**

Close the throttle and brake at the same time progressively with the front and rear brakes. Insert a lower gear depending on speed. On dusty, wet or slippery surfaces, operate the brakes and change down the gears gently without locking the wheels. Locking the wheels leads to swerving or a fall.

When following long descending roads, make use of the engine's braking effect. To do this, insert the 1st or 2nd gear, without however increasing the revs. excessively. In this way you will have to brake much less and the brakes will not overheat.

### **⚠ DANGER**

- IN CASE OF RAIN, AFTER WASHING THE MOTORCYCLE, AFTER IMMERSION IN WATER OR TRAVELLING OVER WET GROUND, THE BRAKING ACTION COULD BE DELAYED BECAUSE OF WET OR DIRTY BRAKE DISCS. THE BRAKES MUST THEREFORE BE OPERATED REPEATEDLY UNTIL THE DISCS ARE DRY AND CLEAN.
- THE BRAKING ACTION CAN ALSO BE DELAYED WHEN TRAVELLING ON DIRTY ROADS OR ROADS COVERED WITH SALT. THE BRAKES MUST BE OPERATED UNTIL THE DISCS ARE CLEAN.
- WHEN THE BRAKE DISCS ARE DIRTY THERE IS GREATER WEAR OF THE PADS AND THE BRAKE DISCS THEMSELVES.
- AFTER USING THE BRAKES, THE DISC, THE PADS, THE CALIPERS AND THE BRAKE FLUID HEAT UP. THE HOTTER THESE PARTS, THE LESS THE BRAKING EFFECT. IN CASE OF OVERHEATING THE ENTIRE BRAKING SYSTEM MAY NOT WORK.
- IF THE FORCE AT THE FRONT BRAKE LEVER OR BRAKE PEDAL IS MINIMAL, THERE COULD BE A FAULT IN THE BRAKING SYSTEM. IN THIS CASE IT IS A GOOD IDEA TO HAVE THE MOTORCYCLE CHECKED BY AN AUTHORISED TM DEALER.

## **STOPPING AND PARKING**

Stop the motorcycle and shift into neutral. To switch the motorcycle off, press, at normal minimum revs, the engine stop switch until the engine has stopped, or the red emergency shutdown button. In this case, it is advised to leave the red button in this way until the engine is started again. Close the fuel tap, park on solid ground and lock the motorcycle using the steering lock.

In the case of the SMR/SMM models, turn the key to switch off the engine.

### **⚠ DANGER**

**MOTORCYCLES PRODUCE A LOT OF HEAT DURING WORKING. THE ENGINE, RADIATORS, EXHAUST SYSTEM, BRAKE DISCS AS WELL AS SHOCK ABSORBERS CAN ALL BECOME VERY HOT. NEVER TOUCH THESE PARTS WHEN DRIVING AND AFTER HAVING SWITCHED THE ENGINE OFF, PARK THE MOTORCYCLE IN A WAY THAT PEDESTRIANS CANNOT TOUCH THEM AND BE BURNED.**

### **⚠ WARNING**

- THE FUEL TAP MUST ALWAYS BE CLOSED WHEN THE MOTORCYCLE IS PARKED. IF IT IS NOT CLOSED, THE FUEL COULD RUN OUT INTO THE CARBURETOR AND PENETRATE THE ENGINE, FLOODING IT.
- NEVER PARK WITH THE ENGINE RUNNING OR PARK THE MOTORCYCLE IN PLACES WHERE THERE IS THE RISK OF FIRE DUE TO DRY GRASS OR OTHER EASILY INFLAMMABLE MATERIALS.

**INDICATIONS REGARDING THE SIDE STAND:**

Push the stand forward until it stops and lean the motorcycle on it. Ensure that the ground is solid and the parking position is stable. For greater safety insert the 1st gear.

**⚠ WARNING**

THE SIDE STAND IS DESIGNED ONLY FOR THE WEIGHT OF THE MOTORCYCLE. NEVER SIT ON THE MOTORCYCLE WHEN IT IS RESTING ON THE SIDE STAND, OTHERWISE THE STAND MAY BE DAMAGED AND THE MOTORCYCLE CAN FALL.

**FUEL**

The 2-stroke engines require a mixture of fuel and oil. TM's 2-stroke engines require a mixing ratio 1:30 so you need to add 33 cc (or ml) of oil for each liter of unleaded fuel. Bel-Ray H1-R is the only synthetic oil that TM approves, uses and recommends

**⚠ WARNING**

FILL THE TANK WITH UNLEADED FUEL WITH A MINIMUM OCTANE NUMBER OF 95. NEVER USE FUEL WITH AN OCTANE NUMBER LOWER THAN 95, BECAUSE THIS WOULD DAMAGE THE ENGINE.

**⚠ DANGER**

**FUEL IS HIGHLY INFLAMMABLE AND TOXIC. HANDLE FUEL WITH GREAT CARE. DO NOT FILL-UP WITH FUEL NEAR TO FLAMES OR CIGARETTES. ALWAYS SWITCH THE ENGINE OFF WHEN FILLING UP WITH FUEL. NEVER POUR FUEL ONTO THE ENGINE OR ONTO THE EXHAUST PIPE. IF ANY FUEL IS ACCIDENTLY POURED ONTO THESE PARTS, DRY IT IMMEDIATELY USING A CLOTH. IF FUEL IS SWALLOWED OR SPRAYED INTO THE EYES, SEEK MEDICAL HELP IMMEDIATELY.**

Fuel expands when heated. Therefore, never fill the tank completely with high environmental temperatures.



**MAINTENANCE**

**AND**

**LUBRICATION**

**TABLE**

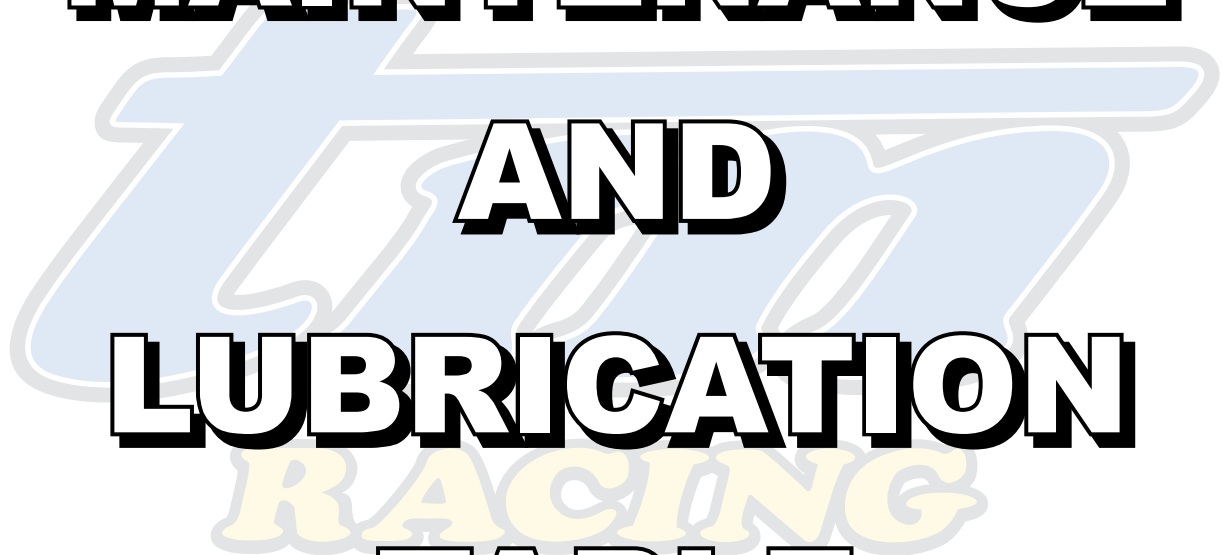

**MAINTENANCE AND LUBRICATION TABLE 250/300 END/SMR/SMM STREET/HOBBY USE**

<b>A CLEAN VEHICLE ALLOWS QUICKER AND THEREFORE CHEAPER INSPECTIONS</b>		<b>1<sup>ST</sup> SERVICE AFTER 3 HOURS</b>	<b>EVERY 30 HOURS</b>	
<b>ENGINE</b>	Replacement of transmission oil	•	•	
	Clean of drain bolt	•	•	
	Check conditions and unbent positioning of rubber pipes	•	•	
	Check tightness of engine fastening screws	•	•	
<b>CARBURETOR</b>	Check fixing for carburetor to engine and filter case		•	
	Check idle speed adjustment	•	•	
	Check conditions and unbent positioning of vent pipes	•	•	
<b>SERVICES</b>	Check for leaks of the cooling system and coolant level	•	•	
	Check for leaks and tightness of all oil drain screws		•	
	Check conditions, smoothness and unbent positioning, of all pipes and cables adjustment and lubrication of throttle and decompressor cables	•	•	
	Check fluid level in the hydraulic brake and clutch reservoirs	•	•	
	Clean filter case and air filter		•	
	Check conditions and unbent positioning of cables		•	
	Check headlamp orientation		•	
	Check electric system (head light, high-beam, stop, indicators, lights, horn, OFF button)	•	•	
	<b>BRAKES</b>	Check brake fluid level, pad thickness, brake discs	•	•
		Check conditions of brake hoses	•	•
Check functionality, adjustment, smoothness and free play of front brake lever and brake pedal		•	•	
Check brake hoses screws tightness		•	•	
<b>CYCLE PART</b>	Check for leaks and working of shock absorber and forks	•	•	
	Clean dust screen		•	
	Bleed fork leg		•	
	Check rear suspension mechanical linkage screw tightness		•	
	Check and adjustment of steering bearings	•	•	
	Check tightness of chassis screws (fork clamps, fork legs, wheels axles nuts and screws, rear fork axle, shock absorber)	•	•	
<b>WHEELS</b>	Check spoke tension and trueness of rims		•	
	Check tyre conditions and pressure	•	•	
	Check chain wear, chain link, sprockets, chain tension	•	•	
	Chain lubrication	•	•	
	Check wheel bearing play	•	•	

**OTHER IMPORTANT MAINTENANCE OPERATIONS RECOMMENDED EVERY YEAR**

	<b>EVERY YEAR</b>
Complete fork maintenance	•
Complete shock absorber maintenance	•
Cleaning and greasing of steering bearings and related sealing elements	•
Cleaning and tuning of the carburetor	•
Replacement of silencer packing material	•
Treatment of electric contacts and switches with contact spray	•
Replacement of hydraulic clutch fluid	•
Replacement of brake fluid	•

The distance between maintenance intervals should not be exceeded by more than 2 hours.  
 THE MAINTENANCE CARRIED OUT BY THE AUTHORISED TM DEALER DOES NOT REPLACE THE CHECKS AND MAINTENANCE CARRIED OUT BY THE RIDER .



**TABELLA MANUTENZIONE E LUBRIFICAZIONE 250/300 END/MX COMPETITION USE**

<b>A CLEAN VEHICLE ALLOWS QUICKER AND THEREFORE CHEAPER INSPECTIONS</b>		<b>1<sup>ST</sup> SERVICE AFTER 2 HOURS</b>	<b>EVERY RACE</b>
<b>ENGINE</b>	Replacement of transmission oil	•	•
	Clean of drain bolt	•	•
	Check condition and unbent positioning of rubber pipes	•	•
	Check tightness of engine fastening screws	•	•
<b>CARBURETOR</b>	Check fasteners for carburetor to engine and filter case		•
	Check idle speed adjustment	•	•
	Check conditions and unbent positioning of vent pipes	•	•
<b>SERVICES</b>	Check for leaks of the cooling system and coolant level	•	•
	Check for leaks and screws tightness of the all exhaust system		•
	Check conditions, smoothness and unbent positioning, adjustment and lub. of command cables	•	•
	Replacement of silencer packing material		•
	Check fluid level in the hydraulic clutch reservoir	•	•
	Cleaning of filter case and air filter		•
	Check conditions and unbent positioning of cables		•
	Check head light orientation (END)		•
	Check electric system (head light, high beam, stop, indicators, lights, horn - END version), OFF button	•	•
	<b>BRAKES</b>	Check brake fluid level, pad thickness, brake discs	•
Check conditions of brake hoses		•	•
Check functionality, adjustment, smoothness and free play of front brake lever and brake pedal		•	•
Check brake hoses screws tightness		•	•
<b>CYCLE PART</b>	Check for leaks and working of shock absorber and forks	•	•
	Clean dust screen		•
	Bleed fork legs		•
	Check rear suspension mechanical linkage screw tightness		•
	Check and adjustment of steering bearings	•	•
	Check tightness of chassis screws and bolts (fork clamps, fork legs, wheel axles nuts and screws, rear fork axle, shock absorber)	•	•
<b>WHEELS</b>	Check spoke tension and trueness of rims		•
	Check tyre condition and pressure	•	•
	Check chain wear, chain link, sprockets and guides, chain tension	•	•
	Chain lubrication	•	•
	Check wheel bearing play	•	•

**OTHER IMPORTANT MAINTENANCE OPERATIONS RECOMMENDED EVERY 3 RACES**

	<b>EVERY 3 RACES</b>
Complete fork maintenance	•
Complete shock absorber maintenance	•
Cleaning and greasing of steering bearings and related sealing elements	•
Cleaning and tuning of the carburetor	•
Treatment of electric contacts and switches with contact spray	•
Replacement of hydraulic clutch fluid	•
Replacement of brake fluid	•

The distance between maintenance intervals should not be exceeded by more than 2 hours.  
 THE MAINTENANCE CARRIED OUT BY THE AUTHORISED TM DEALER DOES NOT REPLACE THE CHECKS AND MAINTENANCE CARRIED OUT BY THE RIDER .

**BRIEF CHECK AND MAINTENANCE OPERATIONS TO BE PERFORMED BY THE RIDER/PILOT**

	<b>BEFORE EVERY START UP</b>	<b>AFTER EVERY WASH</b>	<b>AFTER OFF-ROAD USE</b>
Check engine oil level	•		
Check brake fluid level	•		
Check brake pad wear	•		
Check light system (if present)	•		
Check horn (if present)	•		
Lubrication and adjustment of command cables		•	
Bleed fork legs			•
Disassembly and cleaning of the dust shields			•
Cleaning, lubrication and tension check of final transmission chain		•	•
Cleaning filter case and air filter			•
Check tyre pressure and wear	•		
Check coolant level	•		
Check fuel pipe for leaks	•		
Cleaning of carburetor and jets for dirt and water removal		•	
Check smoothness of all command elements	•		
Check braking effect	•	•	
Treatment of bright metal parts (apart from brake and exhaust system ) with anti-corrosives		•	
Treatment of ignition switch/steering lock with contact spray		•	
Check correct tightness of all screws, nuts and clamps			•

## CHECKS TO BE CARRIED OUT ON ENGINE 250/300 END/MX COMPETITION USE

	15 HOURS	30 HOURS	45 HOURS	60 HOURS	75 HOURS	90 HOURS
Check cylinder and piston wear	•	•	•	•	•	•
Check piston pin (visual check)	•	•	•	•	•	•
Check the exhaust valve	•	•	•	•	•	•
Check reed valve block	•	•	•	•	•	•
Check head and cylinder surfaces	•	•	•	•	•	•
Check small end for marking/damage to plating	•	•	•	•	•	•
Replace conrod, axle and roller cage		•		•		•
Replacement of main bearings		•		•		•
Check complete gearbox including drum and forks	•	•	•	•	•	•
Check clutch plate wear	•	•	•	•	•	•
Check length of clutch springs	•	•	•	•	•	•

### WARNING

IF, AFTER CHECKING, IT IS DETECTED THAT THE WEAR LIMITS OF A SINGLE COMPONENT HAVE BEEN EXCEEDED, THE COMPONENT MUST BE REPLACED.

THE INSTALLATION OF AN HOUR-COUNTER INSTRUMENT IS ADVISED.

THE ABOVE-MENTIONED OPERATIONS MUST BE CARRIED OUT BY AN AUTHORISED TM WORKSHOP.

## CHECKS TO BE CARRIED OUT ON ENGINE 250/300 END/SMR/SMM STREET/HOBBY USE

	30 HOURS	60 HOURS	90 HOURS	120 HOURS	150 HOURS	180 HOURS
Check cylinder and piston wear	•	•	•	•	•	•
Check piston pin (visual check)	•	•	•	•	•	•
Check the exhaust valve	•	•	•	•	•	•
Check reed valve block	•	•	•	•	•	•
Check head and cylinder surfaces	•	•	•	•	•	•
Check small end for marking/damage to plating	•	•	•	•	•	•
Replace conrod, axle and roller cage		•		•		•
Replacement of main bearings		•		•		•
Check complete gearbox including drum and forks	•	•	•	•	•	•
Check clutch plate wear	•	•	•	•	•	•
Check length of clutch springs	•	•	•	•	•	•

### WARNING

IF, AFTER CHECKING, IT IS DETECTED THAT THE WEAR LIMITS OF A SINGLE COMPONENT HAVE BEEN EXCEEDED, THE COMPONENT MUST BE REPLACED.

THE INSTALLATION OF AN HOUR-COUNTER INSTRUMENT IS ADVISED.

THE ABOVE-MENTIONED OPERATIONS MUST BE CARRIED OUT BY AN AUTHORISED TM WORKSHOP.

**CHECKS TO BE CARRIED OUT ON ENGINE 85/100 MX  
HOBBY USE**

	30 HOURS	60 HOURS	90 HOURS	120 HOURS	150 HOURS	180 HOURS
Check cylinder and piston wear	•	•	•	•	•	•
Check piston pin (visual check)	•	•	•	•	•	•
Check the discharge valve	•	•	•	•	•	•
Check lamellar body	•	•	•	•	•	•
Check head and cylinder surfaces	•	•	•	•	•	•
Check small end for marking/damage	•	•	•	•	•	•
Replace conrod, axle and roller cage		•		•		•
Replacement of main bearings		•		•		•
Check complete gearbox including drum and forks	•	•	•	•	•	•
Check clutch plate wear	•	•	•	•	•	•
Check length of clutch springs	•	•	•	•	•	•

**WARNING**

IF, AFTER CHECKING, IT IS DETECTED THAT THE WEAR LIMITS OF A SINGLE COMPONENT HAVE BEEN EXCEEDED, THE COMPONENT MUST BE REPLACED.

THE INSTALLATION OF AN HOUR-COUNTER INSTRUMENT IS ADVISED.

THE ABOVE-MENTIONED OPERATIONS MUST BE CARRIED OUT BY AN AUTHORISED TM WORKSHOP.

**CHECKS TO BE CARRIED OUT ON ENGINE 125/144 END/MX/SMR/SMM  
STREET/HOBBY USE**

	30 HOURS	60 HOURS	90 HOURS	120 HOURS	150 HOURS	180 HOURS
Check cylinder and piston wear	•	•	•	•	•	•
Check piston pin (visual check)	•	•	•	•	•	•
Check the discharge valve	•	•	•	•	•	•
Check lamellar body	•	•	•	•	•	•
Check head and cylinder surfaces	•	•	•	•	•	•
Check small end for marking/damage	•	•	•	•	•	•
Replace conrod, axle and roller cage		•		•		•
Replacement of main bearings		•		•		•
Check complete gearbox including drum and forks	•	•	•	•	•	•
Check clutch plate wear	•	•	•	•	•	•
Check length of clutch springs	•	•	•	•	•	•

**WARNING**

IF, AFTER CHECKING, IT IS DETECTED THAT THE WEAR LIMITS OF A SINGLE COMPONENT HAVE BEEN EXCEEDED, THE COMPONENT MUST BE REPLACED.

THE INSTALLATION OF AN HOUR-COUNTER INSTRUMENT IS ADVISED.

THE ABOVE-MENTIONED OPERATIONS MUST BE CARRIED OUT BY AN AUTHORISED TM WORKSHOP.

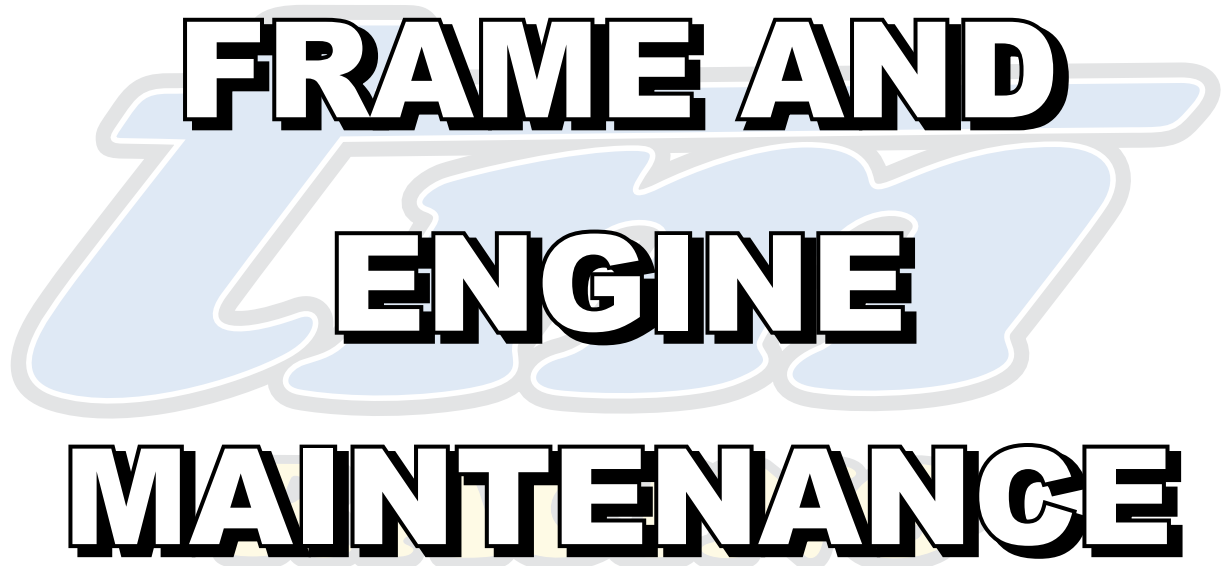

**FRAME AND  
ENGINE  
MAINTENANCE**

## **⚠ DANGER**

ALL MAINTENANCE AND ADJUSTMENT OPERATIONS THAT ARE MARKED WITH (A) REQUIRE TECHNICAL MASTERY. FOR THIS REASON IT IS IN THE INTEREST OF YOUR SAFETY TO HAVE THESE OPERATIONS CARRIED OUT EXCLUSIVELEY BY A SPECIALISED TM WORKSHOP WHERE YOUR MOTORCYCLE WILL BE MAINTAINED IN AN OPTIMAL MANNER BY SPECIFICALLY TRAINED STAFF.

## **⚠ WARNING**

- IF POSSIBLE, DO NOT USE HIGH PRESSURE JETS WHEN WASHING THE MOTORCYCLE BECAUSE THE WATER COULD PENETRATE INTO THE BEARINGS, THE CARBURETOR, ELECTRIC CONNECTORS, ETC.
- WHEN TRANSPORTING YOUR TM, ENSURE THAT IT IS WELL-HELD IN A VERTICAL POSITION USING BELTS OR OTHER MECHANICAL FIXING DEVICES AND ENSURE THAT THE FUEL TAP IS SWITCHED OFF. IF THE MOTORCYCLE SHOULD FALL, FUEL COULD ESCAPE FROM THE CABURETOR OR TANK.
- TO FIX THE SHROUDS TO THE TANK ONLY USE THE SPECIAL SCREWS WITH THE CORRECT LENGTH OF THREAD FOR TM BIKES. IF YOU USE DIFFERENT SCREWS OR LONGER SCREWS, THE TANK COULD BE DAMAGED WITH CONSEQUENT FUEL LEAK.
- DO NOT USE NOTCHED WASHERS OR SPRING WASHERS FOR THE ENGINE FASTENING SCREWS, BECAUSE THEY COULD PENETRATE INTO PARTS OF THE FRAME AND LOOSEN CONTINUALLY. USE SELF-LOCKING NUTS.
- LEAVE THE MOTORCYCLE TO COOL BEFORE STARTING ANY MAINTENANCE. THIS WILL PREVENT BURNS.
- DISPOSE OF OILS, GREASES, FILTERS, FUELS, DETERGENTS, ETC. IN A REGULAR MANNER. COMPLY WITH THE RESPECTIVE REGULATIONS OF YOUR COUNTRY.
- DISPOSE OF WASTE OIL IN A REGULAR MANNER ! NEVER POUR OLD OIL INTO DRAINS OR RIVERS.

## **CHECK OF STEERING BEARINGS AND PLAY ADJUSTMENT (A)**

Periodically check the play of the steering bearings. For the check, lift the front wheel and shake the fork forward and backwards. For adjustment, loosen the four M8 screws (1) and nut (2) of the head of the fork and act on the ring nut (3), tightening it until there is no more play. Do not tighten the ring nut further to prevent damage to the bearings. Tighten the fork head nut and successively the four M8 screws to 20 Nm. Check for a smooth steering.

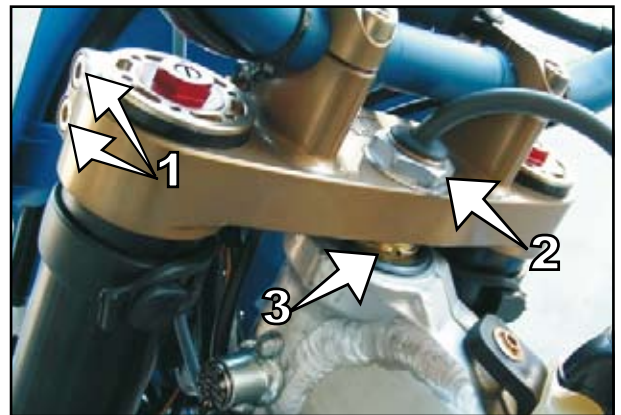

## **⚠ DANGER**

IF THE STEERING BEARINGS DO NOT HAVE THE CORRECT CLEARANCE, THE BEHAVIOUR ON THE ROAD WILL BE IRREGULAR AND YOU COULD LOOSE CONTROL OF THE MOTORCYCLE.

## **⚠ WARNING**

MAKING LONG JOURNEYS WITH INCORRECT STEERING BEARINGS ADJUSTMENT, YOU RISK TO DAMAGE THE BEARINGS AND THEIR SEATS IN THE FRAME.

The steering bearings should be re-greased at least once a year.

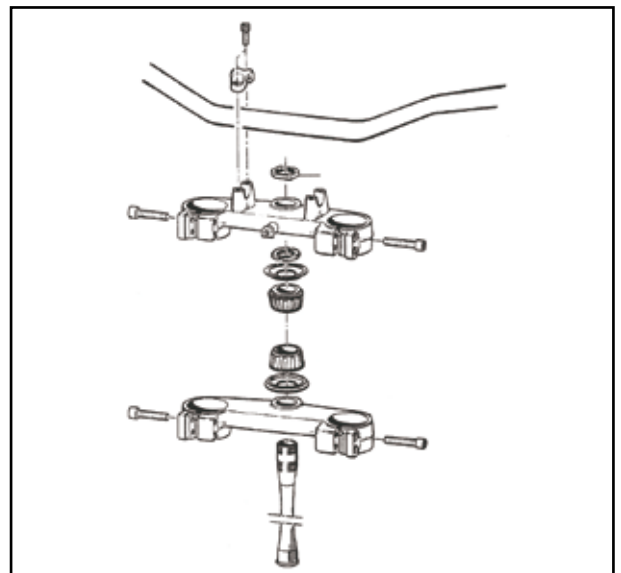

**TELESCOPIC FORK VENT SCREWS**

Every 5 hours of use in competition it is necessary to release the the air-pressure from inside the fork.

The Marzocchi fork features a tyre valve (1) protected by a rubber cap (2). Remove the rubber cap and press gently the valve stem.

Before operating on the screws or on the valve, lift the motorcycle onto the stand in a way that the front wheel does not touch the ground. If the motorcycle is used mainly on roads, it is sufficient only to carry out this operation during periodical maintenance.

**⚠ WARNING**

VERY HIGH PRESSURE INSIDE THE FORK CAN CAUSE THE FORK TO LEAK. IF YOUR FORK PRESENTS A LEAK, LOOSEN THE VENT SCREWS BEFORE HAVING THE SEALING ELEMENTS REPLACED.

**CLEANING OF TELESCOPIC FORK DUST SCRAPER**

The dust scraper (4) must scrape the dust and dirt from the fork rods. However, after some time, dirt may also reach behind the dust scrapers. If the dirt is not removed, the oil seal units, which are found behind, may leak.

Use a screwdriver to lever the dust scraper from the outside legs and push it downwards.

Clean the dust scraper, the outside legs and the rods carefully. Oil them well with silicone spray or with engine oil. Finally, push the dust scraper manually into the outside legs.



**BASIC CALIBRATION OF THE CYCLE PART ON THE BASIS OF THE PILOT'S WEIGHT**

To obtain optimal driving features of the motorcycle and to prevent damage to the fork, rear shock, rear swing arm and frame, it is necessary that the basic calibration of the suspension is adapted to your body weight. In the delivery status, the off-road TM motorcycles are calibrated on a pilot weight (with complete protective clothing) of 70 – 80 kg. If your weight is not within these values, you must adequately adapt the basic calibration of the suspensions. Minor weight changes can be compensated by varying the spring pre-load. For greater variations, suitable springs rates must be used.

**SHOCK CALIBRATION AND SPRING CHECK**

If the rear shock spring is suitable for your weight, it can be seen by lowering in running order. However, before establishing the lowering in running order, static lowering must be adjusted correctly.

**ESTABLISHING REAR SHOCK STATIC LOWERING**

The static lowering should be 35 mm. Variations of more than 2 mm can notably influence driving of the motorcycle.

Procedure:

- Position the motorcycle on a stand so that the rear wheel does not touch the ground.
- Measure the distance between the rear wheel axle and a fixed point (e.g.. a mark on the side panel) paying attention that the straight line that joins the axle and the fixed point is as perpendicular as possible to the ground and make note of the value as A.
- Rest the motorcycle back on the ground.
- Ask a helper to hold the motorcycle in a vertical position.
- Measure the distance between the rear wheel axle and the fixed point again. Make note of this measurement as B.
- The static lowering is the difference between measurement A and B.

**EXAMPLE:**

Motorcycle on stand (measurement A)..... 600 mm  
 Motorcycle on the ground, not loaded (measurement B) .. - 565 mm  
 Static lowering ..... 35 mm

If the static lowering is smaller, the rear shock spring pre-load must be decreased. If the static lowering is greater, the spring pre-load must be increased. See variation of rear shock spring pre-load chapter.





## ESTABLISHING REAR SHOCK LOWERING IN RIDING CONDITIONS

- Now, with the help of a person who holds the motorcycle, sit on the motorcycle wearing all protective clothing (with feet on the footrests) and rock up and down a few times to normalise the set-up of the rear suspension.
- A third person must then measure the distance between the same points, with the motorcycle loaded and note this measurement as C.
- Lowering in running order is the difference between measurements A and C.

### EXAMPLE:

Motorcycle on stand (measurement A) .....	600 mm
Motorcycle on the ground loaded with the pilot's weight (measurement C) .....	- 510 mm
Lowering in riding conditions.....	90 mm

Lowering in riding conditions should be 90÷105 mm.

If lowering in riding conditions is less than 90 mm, the spring is too hard (spring rate too high).

If the lowering exceeds 105 mm, the spring is too soft (spring rate too low).

The spring rate is indicated on the outside of the spring wire.

After mounting a different spring, static lowering must be adjusted again to 35 mm (± 2 mm).

According to our experience, the dampening grade in compression can remain unvaried. With a softer spring, the dampening grade in rebound can be reduced by some clicks, with a harder spring, increased by some clicks.



## CHECK TELESCOPIC FORK BASIC CALIBRATION

For several reasons, the exact lowering in running order of the telescopic fork can not be established. Small variations in body weight can be compensated, as for the rear shock, through the spring pre-load. If your telescopic fork, however, frequently bottoms, it is necessary to use an higher rate fork spring to prevent damage to the telescopic fork and frame.



## VARIATION OF TELESCOPIC FORK PRE-LOAD

To vary the spring pre-load on these telescopic forks, it is necessary to disassemble them partially (see specific manual of the fork mounted on the motorcycle). It is possible to add pre-load spacers. The fork springs however, can be pre-loaded to a max. of 20 mm.

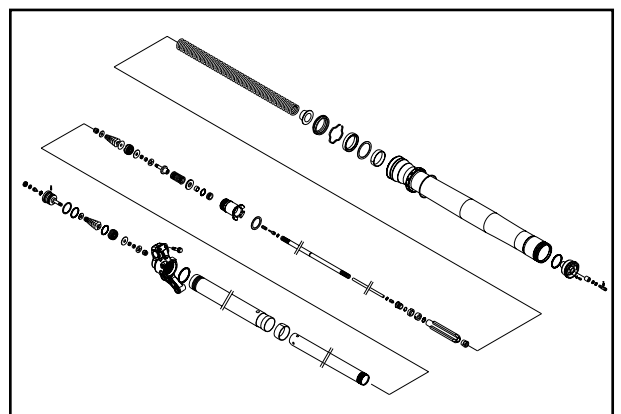

## REPLACEMENT OF FORK SPRINGS

If your body weight is less than 70 kg or exceeds 80 kg, adequate fork springs must be used.

If you are in doubt or have any questions, please contact your authorised TM dealer.

According to our experience, the dampening grade in compression can remain unvaried. With a softer spring, the dampening grade in rebound can be reduced by some clicks, with a harder spring, increased by some clicks.

### **⚠ WARNING**

FOR FURTHER AND MORE DETAILED INFORMATION REGARDING THE FORK REFER TO THE INSTRUCTION BOOK SUPPLIED BY THE MANUFACTURER OF THE FORK AND GIVEN BY TM ACCOMPANYING THE MOTORCYCLE.

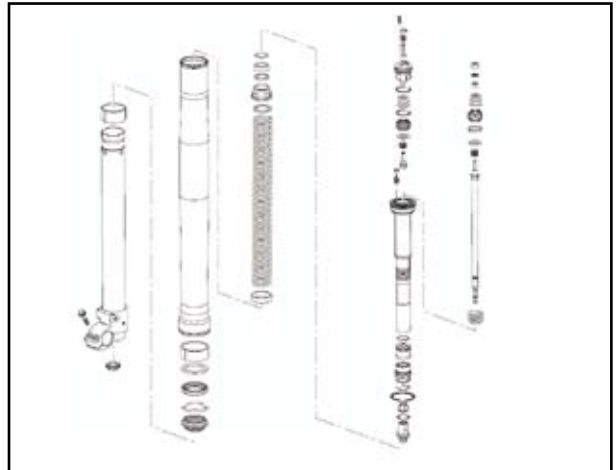

## VARIATION OF REAR SHOCK SPRING PRELOAD

The preload of the spring can be varied by turning the adjustment ring nut (1) (4) (6). With this aim, it is advised to disassemble the rear shock and clean it well before operating.

INDICATION:

- Before varying the spring preload you should take note of the basic adjustment - e.g. how many thread turns are visible above the lock ring nut (6).
- By 1 turn of the adjustment ring nut (1) (4) (6) the spring pre-load varies by 1.5 mm.

### **SACHS**

Loosen the lock ring nut (2) and turn the adjustment ring nut (1). Turning it anticlockwise (viewed from the top) the preload decreases, turning it clockwise (viewed from the top) the preload increases.

After the adjustment, tighten the lock ring nut (6).

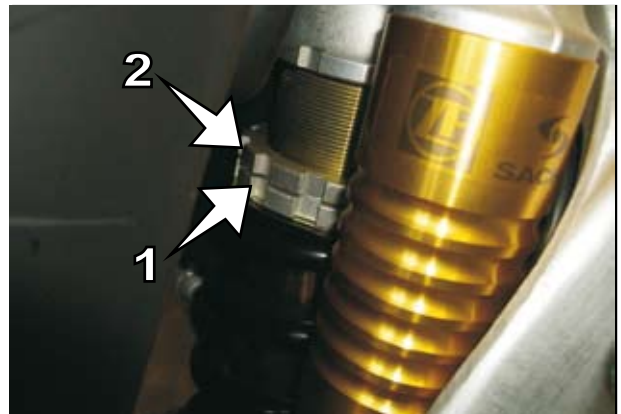

### **OHLINS**

Loosen the clamp (3) using a 4mm. Allen wrench and turn the adjustment ring nut (4). Turning it anticlockwise (viewed from the top) the preload decreases, turning it clockwise (viewed from the top) the preload increases.

Tighten the clamp closure (3) after adjustment.

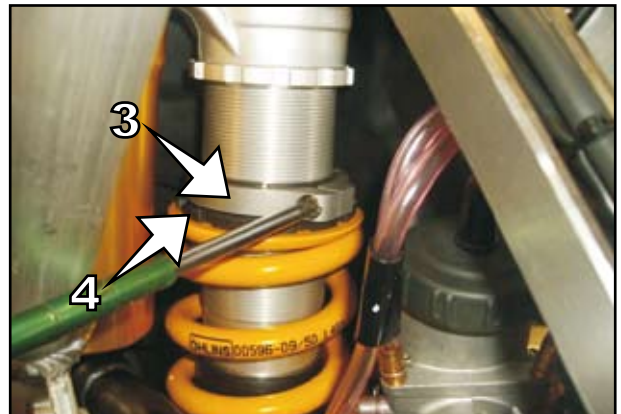

### **TM**

By means of a 4mm. Allen wrench loosen the locking screw (5) of the ring nut (6) and turn the ring nut itself.

By turning it anticlockwise (seen from the top) the preload decreases, turning it clockwise the preload increases.

Tighten the locking screw after the adjustment.

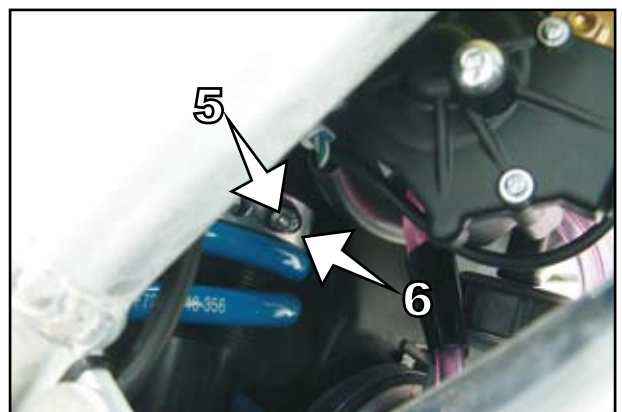

## REAR SUSPENSION MECHANICAL LINKAGE

The rear suspension of all TM motorcycles has a link-rod and rocker mechanism that progressively changes the lever ratio between the wheel and the rear shock.

This mechanism works on bearings, which must be cleaned and greased at the envisioned intervals to maintain the working of the suspension efficient.

When cleaning the motorcycle with high pressure cleaning devices, do not aim the jet directly onto the suspension mechanical linkage.



## CHECK CHAIN TENSION

Put the motorcycle onto the central stand to check chain tension. Push the lower part of the chain upwards to the end of the drive chain slider.

The upper part of the chain (A) must be taught. The distance between the chain and rear fork must be about 10-15 mm. Adjust the tension, if necessary.



### **⚠ DANGER**

- IF THE CHAIN IS TOO TIGHT , THE FINAL TRANSMISSION COMPONENTS (CHAIN, GEARBOX AND REAR WHEEL BEARINGS) ARE GREATLY STRESSED. AS WELL AS A PREMATURE WEAR, IN EXTREME SITUATIONS THE CHAIN OR GEARBOX DRIVEN SHAFT MAY BREAK.
- IF, HOWEVER, CHAIN TENSION IS INSUFFICIENT, IT CAN EXIT FROM THE SPROCKET AND LOCK THE REAR WHEEL OR DAMAGE THE ENGINE.
- IN BOTH CASES IT IS EASY TO LOOSE CONTROL OF THE MOTORCYCLE.

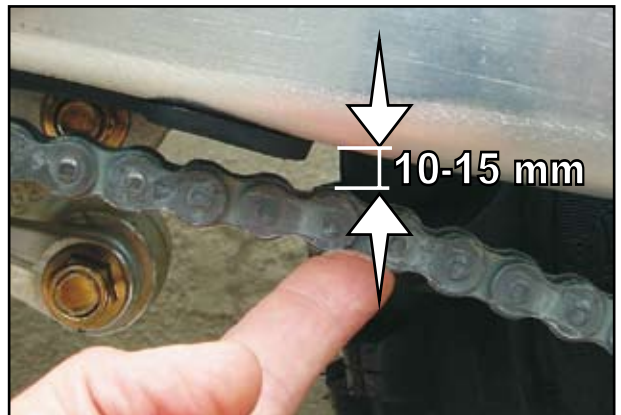

## ADJUSTMENT OF CHAIN TENSION (ALL MODELS EXCEPT SMM)

Loosen the wheel axle nut (1), loosen the counter-nuts (2) and turn the adjustment bolts (3) to the left and to the right by the same amount. To increase chain tension, unscrew the adjustment bolts. To decrease chain tension, screw the adjustment bolts. Reach correct chain tension.

For correct alignment of the rear wheel, the marks (4) on the right and left chain-tensioner must aligned with respect to the reference markings (5). Tighten the adjustment screw counter-nuts. Before locking the wheel axle nut, check that the chain-tensioners (6) are laying on the heads of the adjustment bolts and that the rear wheel is aligned with the front wheel. Tighten the wheel axle nut to 80 Nm.

### **⚠ ATTENTION**

- IF YOU DO NOT HAVE A DYNAMOMETRIC WRENCH FOR ASSEMBLING, HAVE THE TIGHTENING TORQUE CHECKED BY A SPECIALISED TM WORKSHOP AS SOON AS POSSIBLE. A LOOSE WHEEL AXLE MAY CAUSE UNSTABLE DRIVING OF THE MOTORCYCLE.

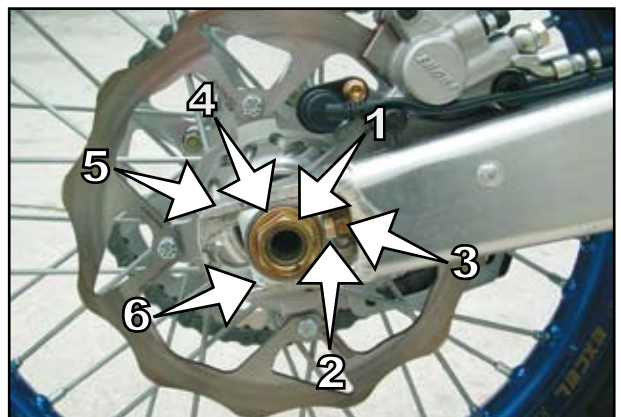

## ADJUSTMENT OF CHAIN TENSION (SMM)

Loosen both the locking screws (1) of the rear eccentric hub in a way that the hub itself can turn around its axis.

Using the relevant TM tool, code F50806 (2), turn the hub until correct chain tension is reached. Tighten the two locking screws to 30 Nm.

Since the movement is an eccentric system, alignment of the rear wheel is unvaried and no further adjustment is required.

At the same time, by turning the hub a slight variation in the height of the rear wheel axle may be verified and consequently of the rear part of the motorcycle. It is possible to compensate this, by varying the projection of the fork legs from the upper clamp.

For example, if the motorcycle, by effect of chain adjustment, has lifted by 5mm. at the rear, it is advised to decrease the projection of the fork rods by about 5mm. to also raise the front and restore the original leveling of the motorcycle.

It is advised to use the TM tool, code F50806, pairing with two M8 screws and two nuts to turn the hub inserting the two screws into the two holes in the hub itself.

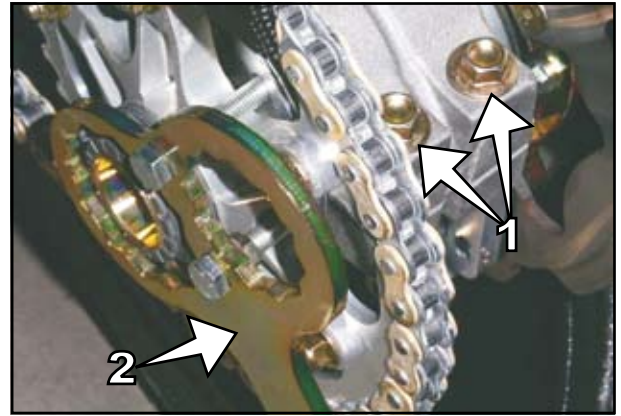

### **⚠ ATTENTION**

- IF YOU DO NOT HAVE SUITABLE EXPERIENCE, IT IS ADVISED TO HAVE THE OPERATION CARRIED OUT BY A SPECIALISED TM WORKSHOP.

## CHAIN MAINTENANCE

Chain duration depends most of all on maintenance. Chains without O-rings must be regularly cleaned with petroleum and then immersed in warm chain oil or treated with chain spray. Maintenance of chains with O-rings is reduced to a minimum. The best cleaning method is using lots of water. Never use brushes or solvents to clean the chain. When the chain is dry, use a chain spray that is especially suitable for chains with O-rings.

### **⚠ DANGER**

**DO NOT ALLOW THE LUBRICANT TO REACH THE REAR TYRE OR THE BRAKE DISC, OTHERWISE ADHERENCE TO THE GROUND OF THE REAR WHEEL AND REAR BRAKE ACTION COULD BE NOTABLY REDUCED AND IT COULD BE EASY TO LOOSE CONTROL OF THE MOTORCYCLE.**

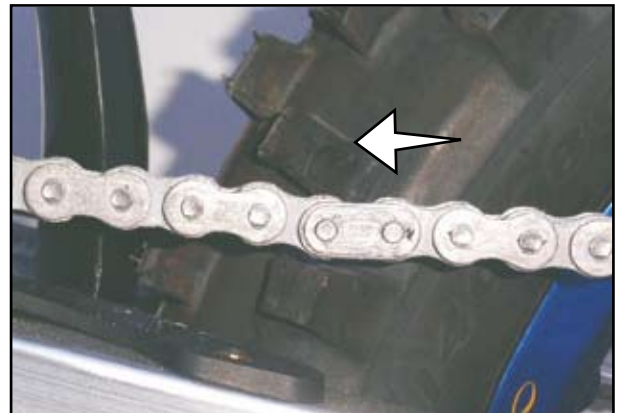

### **⚠ WARNING**

ON MOUNTING THE CHAIN SPLIT LINK, THE CLOSED PART MUST BE IN THE DIRECTION OF MOVEMENT.

Always check both engine and rear wheel sprockets and drive slider for wear. If necessary, replace these parts.

## CHAIN WEAR

To check chain wear follow carefully the instructions given below :  
 put the gear into neutral, pull the upper part of the chain in an upward direction with a force of 10 - 15 kilograms (see figure). Now, measure the distance of 18 links on the lower part of the chain. If the distance exceeds 272 mm it is advised to replace the chain. The chains are not always worn in a even way. For this reason the measurement must be taken in different points on the chain.

### INDICATION:

When a new chain is mounted, also replace the sprockets. A new chain wears more quickly on old and worn sprockets.

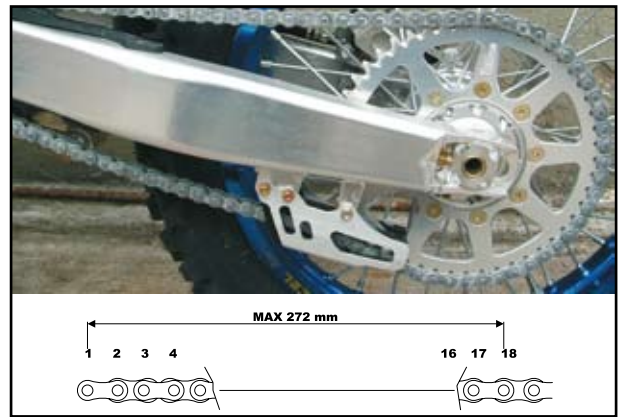

### WARNING

WHEN THE CHAIN SPROCKETS ARE REPLACED, IT IS ADVISED TO MOUNT NEW SELF-LOCKING NUTS AND TO TIGHTEN WITH CROSS SEQUENCE. TIGHTENING TORQUE AT NUTS 35 NM.

## BASIC INDICATIONS FOR TM DISC BRAKES

### CALIPERS :

The mounting system of the calipers of these models is "floating", i.e they are not rigidly joined to their support. The lateral compensation always allows the pads to work in the best way on the discs. The brake caliper fastening screws must be assembled using Loctite 243 and tightened at 25 Nm.

The front calipers of the SMR/SMM models are an exception as they are fixed-type.

### PADS:

The minimum thickness of the friction material cannot go under the limit of 1mm.

In case of replacement, it is advised always to use TM original spare parts for your motorcycle.

### BRAKE DISCS:

With wear the thickness of the brake disc is reduced in the contact area of the pads (1). In the thinnest point (A) the brake disc may present max. wear of 0.4 mm with respect to original thickness. The original thickness can be measured in point (B) outside of the contact area. Check wear in different points.

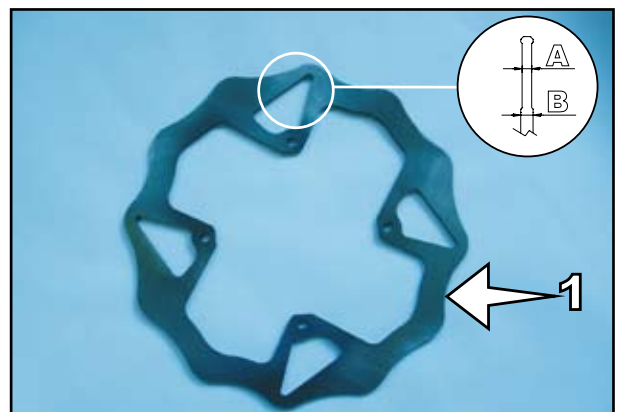

### DANGER

- BRAKE DISCS WITH WEAR EXCEEDING 0.4 MM ARE A RISK FOR SAFETY. WHEN THE LIMIT OF WEAR HAS BEEN REACHED, HAVE THE BRAKE DISCS REPLACED IMMEDIATELY.
- IT IS COMPULSORY TO HAVE THE BRAKE UNIT REPAIRED BY A TM AUTHORIZED WORKSHOP.

## BRAKE FLUID RESERVOIRS:

The front and rear brake liquid reservoirs are dimensioned in a way that topping-up is not necessary even if the brake pads are worn. In fact, when the pads are worn, the fluid in the hoses tends to occupy the space left by the small pistons, which have moved so that the pads always lay on the disc. If the level of brake fluid falls below the minimum value, it indicates that there is a leak in the braking system or brake pad wear is beyond accepted limits.

## BRAKE FLUID:

The braking system is filled by TM with top-quality DOT 4 brake fluid. We recommend that top-ups and complete replacement are carried out using the same type of fluid (DOT 4).

### **⚠ DANGER**

HAVE THE BRAKE FLUID REPLACED AT LEAST ONCE A YEAR. IF YOU WASH THE MOTORCYCLE FREQUENTLY, IT SHOULD BE REPLACED MORE OFTEN. THE BRAKE FLUID SOAKS WATER. IN OLD FLUID THEREFORE IT IS POSSIBLE THAT STEAM BUBBLES FORM EVEN AT LOW TEMPERATURES AND THE BRAKING SYSTEM DOES NOT WORK CORRECTLY.



## FRONT BRAKE NISSIN PUMP (END/MX)

### FRONT BRAKE LEVER ADJUSTMENT

The distance of the front brake lever from the handlebar grip can be adjusted through the adjustment screw (1). Loosen the lock nut (2) and turn the screw clockwise to increase the distance, anticlockwise to reduce the distance. Re-tighten the lock nut (2).

### **⚠ WARNING**

AT THE END OF THE OPERATION VERIFY THAT THE FRONT BRAKE LEVER HAS A FREE STROKE BEFORE THE BRAKE STARTS TO LOCK THE WHEEL AND THAT THE FRONT WHEEL CAN ROTATE FREELY WITH THE BRAKE LEVER AT REST. IF THE FREE STROKE IS MISSING, PRESSURE IS FORMED IN THE BRAKING SYSTEM AND THE CONSEQUENCE CAN BE LACK OF FUNCTIONING OF THE FRONT WHEEL BRAKE DUE TO OVERHEATING OR BLOCKING OF THE WHEEL ITSELF.

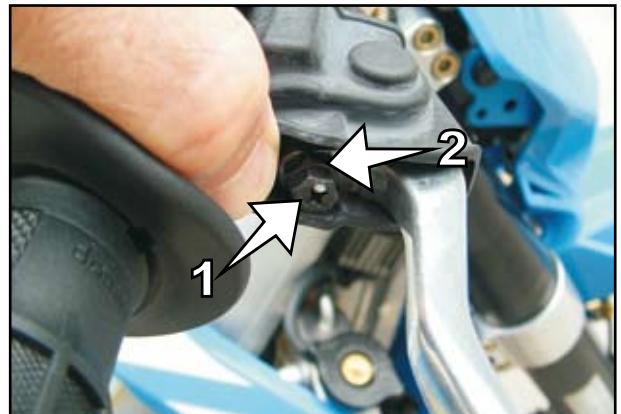

### CHECK FLUID LEVEL

The reservoir is part of the front brake pump positioned on the handlebar and has an inspection window (3): with the tank in the horizontal position, the fluid level must never fall below the centreline on the inspection window.

### **⚠ DANGER**

IF THE LEVEL OF BRAKE LIQUID FALLS BELOW THE MINIMUM VALUE, IT INDICATES A LEAK IN THE BRAKING SYSTEM OR CONSUMPTION OF BRAKE PADS BEYOND THE ACCEPTED LIMITS.



### TOP-UP FRONT BRAKE FLUID (A)

Unscrew and remove the cap (4) and the membrane (5). Keep the reservoir standing up and top-up the brake fluid to the MAX remark on the reservoir. Reassemble the membrane, the cap and tighten. Wash any spilled brake fluid away with water.

### **⚠ DANGER**

- KEEP BRAKE FLUID OUT OF THE REACH OF CHILDREN.
- BRAKE FLUID MAY IRRITATE THE SKIN. DO NOT ALLOW IT TO TOUCH SKIN OR EYES. IF THE BRAKE FLUID SHOULD ACCIDENTLY SPRAY INTO THE EYES, RINSE WELL WITH WATER AND SEEK MEDICAL ASSISTANCE.



## ⚠ WARNING

- DO NOT ALLOW BRAKE FLUID TO COME INTO CONTACT WITH PAINTED PARTS, THE BRAKE FLUID CORRODES PAINT.
- USE ONLY CLEAN BRAKE FLUID OUT OF A HERMETICALLY SEALED CONTAINER.



## FRONT BRAKE BREMBO RADIAL PUMP (SMR/SMM)

### FRONT BRAKE LEVER ADJUSTMENT

The distance of the front brake lever from the handlebar grip can be adjusted through the adjustment knob (6). Turning it clockwise the distance increases, turning it anticlockwise the distance decreases.

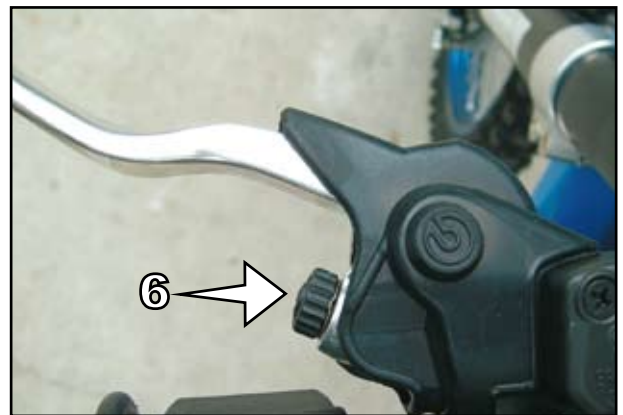

## ⚠ WARNING

AT THE END OF THE OPERATION VERIFY THAT THE FRONT BRAKE LEVER HAS A FREE STROKE BEFORE THE BRAKE STARTS TO LOCK THE WHEEL AND THAT THE FRONT WHEEL CAN ROTATE FREELY WITH THE BRAKE LEVER AT REST. IF THE FREE STROKE IS MISSING, PRESSURE IS FORMED IN THE BRAKING SYSTEM AND THE CONSEQUENCE CAN BE LACK OF FUNCTIONING OF THE FRONT WHEEL BRAKE DUE TO OVERHEATING OR BLOCKING OF THE WHEEL ITSELF.

### CHECK FLUID LEVEL

The reservoir (7) is transparent and allows you to check for the fluid level: with the reservoir standing up, the fluid level must be always between MAX and MIN remarks.

If the fluid level falls below the MIN value, unscrew and remove the cap (8) and the membrane (9). Top-up the fluid to the MAX value and close the tank.



## ⚠ DANGER

IF THE BRAKE FLUID LEVEL FALLS BELOW THE MINIMUM VALUE, IT MIGHT INDICATE A LEAKING IN THE BREAKING SYSTEM OR CONSUMPTION OF BRAKE PADS BEYOND THE ACCEPTABLE LIMIT.

## CHECK FRONT BRAKE PADS

The brake pads can be checked from below. The thickness of the pad friction material must not be less than 1 mm.

**THE THICKNESS OF THE BRAKE PAD THICKNESS MATERIAL MUST NOT BE LESS THAN 1 MM, OTHERWISE THERE COULD BE A FAULT IN THE BRAKES. IN THE INTEREST OF YOUR SAFETY HAVE THE THE PADS REPLACED IN TIME.**

## ⚠ WARNING

IF THE BRAKE PADS ARE REPLACED TOO LATE AND ARE COMPLETELY WORN, THE STEELPARTS OF THE PADS RUB ON THE DISC. THIS LEADS TO A NOTABLE DECREASE IN THE BRAKING EFFECT AND DAMAGE OF THE BRAKE DISC.

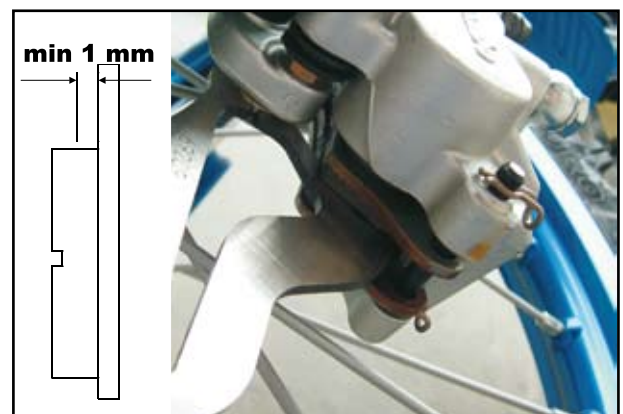

**REPLACEMENT OF FRONT BRAKE PADS (A)**
**FOR ALL MODELS WITH FLOATING CALIPER (END/MX)**

Push the brake caliper towards the disc, in a way that the brake pistons reach their base position. Remove the safety devices (1), extract the pin (2) and remove the pads from the caliper. Use compressed air to clean the brake caliper and the caliper support, check that the driving pin seals are not damaged and, if necessary, grease them.

Mount the right brake pad and fix it with the pin. Mount the left brake pad and insert the pin until it stops. Mount the safety devices. During mounting of the pads, ensure that the protection sheet-steel in the caliper support and the leaf spring are correctly positioned.

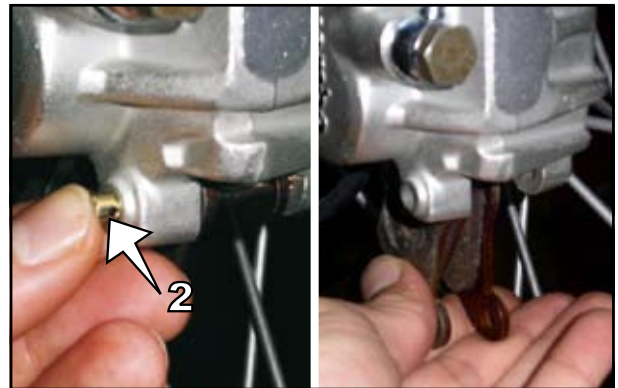
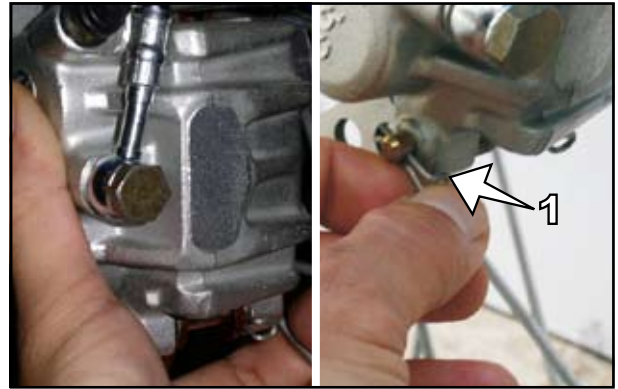
**FOR ALL MODELS WITH FIXED CALIPER (SMR/SMM)**

**RADIAL COUPLING** - Unscrew the two screws M10 (3) and remove the caliper from the fork shoe. Press the two hooks (4) one at a time to release and slide the retainer pins (5) out. Lever on each pair of pads to allow the pistons to go back to their seat. Extract the worn pads and insert the new ones. Repeat the operation for the other pair of pads. Press the two hooks down and re-insert the pins: be sure that they are fully inserted, have their play and are correctly attached. Reassemble the caliper and tighten the M10 screws at 40Nm.

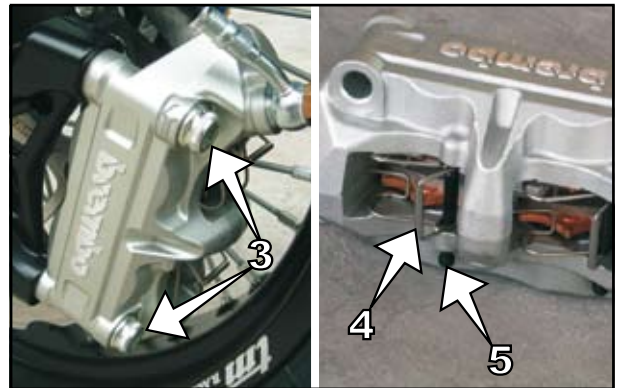
**⚠ WARNING**

- FOR ALL MODELS: WHEN THE CALIPER PISTONS ARE PUSHED BACK TO THEIR SEAT TO PROVIDE ROOM FOR THE NEW PADS, PAY ATTENTION THAT THE FLUID CONTAINED IN THE RESERVOIR HAS THE SPACE TO EXPAND. DO NOT WORK WITHOUT THE CAP MOUNTED, OTHERWISE THE FLUID COULD OVERFLOW AND DAMAGE PARTS OF THE MOTOR-CYCLE.

**⚠ DANGER**

- THE BRAKE DISC MUST ALWAYS BE KEPT FREE FROM OIL AND GREASE. OTHERWISE THE BRAKING EFFECT WOULD BE GREATLY REDUCED.
- AFTER MOUNTING, CHECK THAT THE SAFETY DEVICES ARE CORRECTLY POSITIONED. AFTER EVERY INTERVENTION ON THE BRAKING SYSTEM ACTIVATE THE FRONT BRAKE LEVER AND THE REAR BRAKE PEDAL TO MAKE THE PADS ADHERE TO THE DISC AND TO RESTORE THE CORRECT ADJUSTMENT OF PLAY.



## MODIFICATION OF REAR BRAKE PEDAL BASE POSITION (A)

The base position of the rear brake pedal can be modified in the following way: loosen counter-nut M6 (1) fork side, turn the adjustment screws by acting on the hexagonal head (2). Once the ideal position has been found, tighten the counter-nut.

The pedal free play is given by the stroke of the pump piston; check that the pedal has a free play of about 1.5cm before starting to brake.

### **⚠ WARNING**

IF THERE IS NO FREE PLAY, PRESSURE DEVELOPS IN THE BRAKING SYSTEM AND CONSEQUENTLY THE REAR WHEEL IS BRAKED. THE BRAKING SYSTEM OVERHEATS AND IN EXTREME CASE IT WILL NOT WORK.

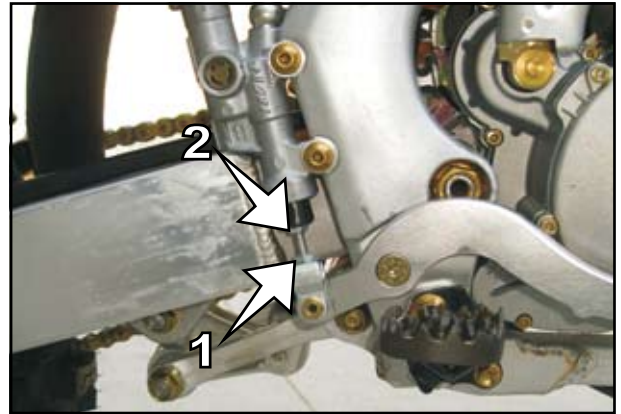

## CHECK REAR BRAKE FLUID LEVEL

### ALL THE MODELS

The reservoir for the rear disc brake fluid is incorporated into the rear brake pump. When the motorcycle is in a vertical position, the level must always be over half way on the window (3) positioned on the body of the pump.

### **⚠ DANGER**

IF THE LEVEL OF THE BRAKE FLUID FALLS BELOW THE MINIMUM LEVEL, IT INDICATES A LEAK IN THE BRAKING SYSTEM OR COMPLETE CONSUMPTION OF THE BRAKE PADS.

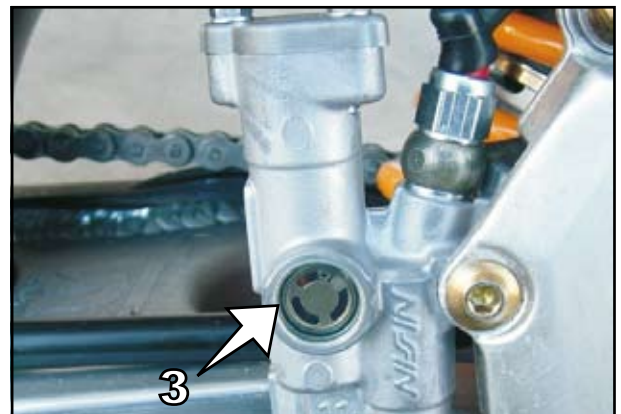

## TOP-UP REAR BRAKE FLUID (A)

### ALL THE MODELS

As soon as the level of rear brake fluid reaches the centreline on the window situated on the pump, it must be topped-up. Unscrew the two screws (4) and remove the lid. Top-up with DOT4 brake fluid to the top of the window. Remount the lid and tighten the screws.

Wash any spilled brake fluid away with water



### **⚠ DANGER**

- NEVER USE DOT5 BRAKE FLUID! IT IS A PURPLE SILICONE OIL-BASED BRAKE FLUID. IT REQUIRES THE USE OF SPECIAL SEALS AND HOSES
- KEEP THE BRAKE FLUID OUT OF CHILDREN'S REACH.
- THE BRAKE FLUID CAN IRRITATE THE SKIN. DO NOT ALLOW IT TO TOUCH THE SKIN OR EYES. IF THE BRAKE FLUID SHOULD SPRAY INTO THE EYES RINSE WELL WITH WATER AND SEEK MEDICAL ATTENTION

### **⚠ WARNING**

- DO NOT ALLOW BRAKE FLUID TO COME INTO CONTACT WITH PAINTED PARTS. BRAKE FLUID CORRODES PAINT !
- USE ONLY CLEAN BRAKE FLUID FROM A HERMETICALLY SEALED CONTAINER.

## CHECK REAR BRAKE PADS

The brake pads must be controlled from the rear side. The thickness of the pad friction material must not be less than 1 mm.

### **⚠ DANGER**

AT THE THINNEST POINT, THE THICKNESS OF THE BRAKE PAD FRICTION MATERIAL MUST NOT BE LESS THAN 1 MM, OTHERWISE A FAULT COULD OCCUR IN THE BRAKES. IN THE INTEREST OF YOUR SAFETY HAVE THE PADS REPLACED IN TIME.

### **⚠ WARNING**

IF THE BRAKE PADS ARE REPLACED TOO LATE SO THAT THE FRICTION MATERIAL IS COMPLETELY CONSUMED, THE STEEL PARTS OF THE PADS RUB ON THE DISC. THIS LEADS TO A NOTEWORTHY DECREASE OF THE BRAKING EFFECT AND DAMAGE OF THE BRAKE DISC.



## REPLACEMENT OF REAR BRAKE PADS (A)

### FOR ALL MODELS WITH FLOATING CALIPER (END/MX/SMR)

Push the brake caliper (1) towards the disc, until the piston reaches its base position. Remove the cap (2) using a screwdriver, unscrew the pin (3) and slide the brake pad out. Pay attention to the plates (4) placed between the pads: these must be remounted accurately. Clean the brake caliper with compressed air and check that the drive pin sheaths are not damaged.

Remount the new pads, paying attention to the positioning of the plates, insert the pin, re-screw it and tighten. Remount the tap using a screwdriver. Tighten well.

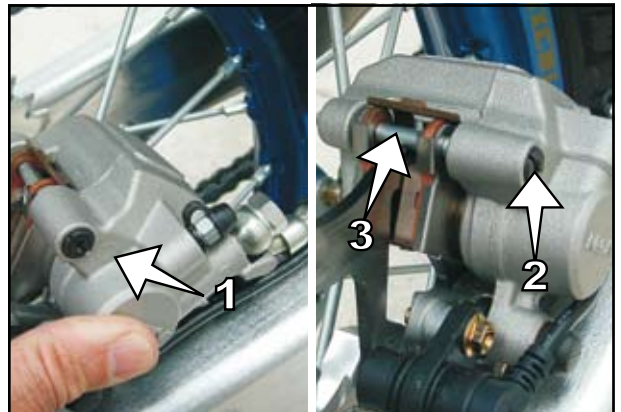

### FOR ALL MODELS WITH FIXED CALIPER (SMM)

Remove the safety ring (5) and slide the pin out (6) hitting with a pin-puller with 4mm. diameter on the same side where the safety ring is found.

### **⚠ DANGER**

- THE BRAKE DISC MUST ALWAYS BE PERFECTLY CLEAN FROM OIL AND GREASE. OTHERWISE THE BRAKING EFFECT WOULD BE GREATLY REDUCED.
- AFTER MOUNTING, CHECK THAT THE SAFETY DEVICES ARE POSITIONED CORRECTLY.
- AFTER EVERY INTERVENTION ON THE BRAKING SYSTEM, ACTIVATE THE FRONT BRAKE LEVER AND THE REAR BRAKE PEDAL TO MAKE THE PADS ADHERE TO THE DISC AND TO RESTORE THE CORRECT ADJUSTMENT OF PLAY.

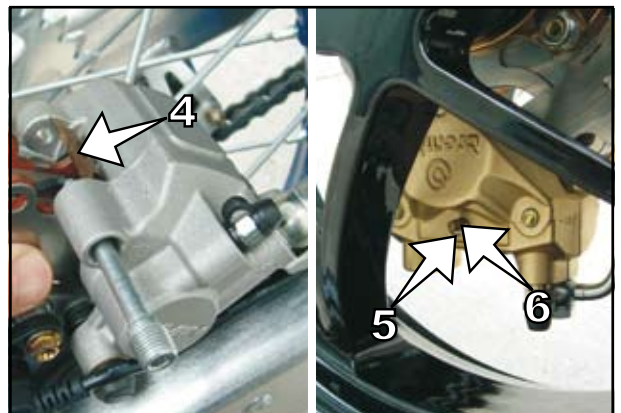

## DISASSEMBLY AND ASSEMBLY OF THE FRONT WHEEL

Position the motorcycle with the frame cradle on a stand in a way that the front wheel does not touch the ground.

Loosen the flanged nut (7), loosen the fastening screws (8) on the left and right fork shoes, finish unscrewing the flanged nut.

Holding the front wheel still, slide the wheel axle out.

If necessary, to help the wheel axle to exit, strike lightly with a mallet (hammer with plastic ends) on the threaded end of the axle itself.

Alternatively, use a normal hammer and place a piece of wood between.

NEVER USE THE HAMMER DIRECTLY ON THE AXLE, YOU RISK TO DAMAGE THE AXLE IRREVERSIBLY.

Slide the front wheel carefully out of the fork.

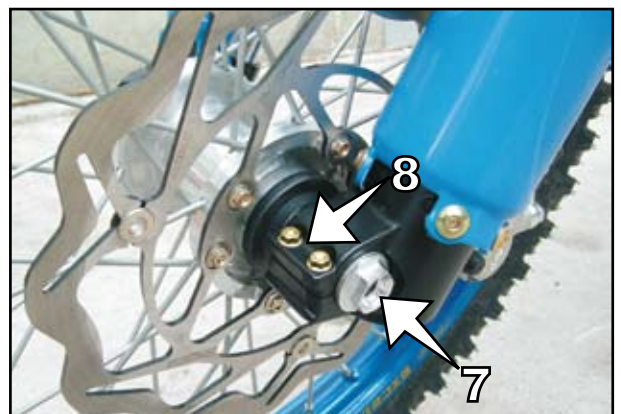

## ⚠ WARNING

- NEVER ACTIVATE THE BRAKE LEVER WHEN THE FRONT WHEEL IS DISASSEMBLED
- ALWAYS POSITION THE WHEEL WITH THE BRAKE DISC UPWARDS TO PREVENT DAMAGE.

To re-assemble the front wheel, insert it carefully into the fork, taking care to insert the disc correctly between the brake pads without damaging them. Position it correctly and mount the wheel axle.

Screw and temporarily tighten the flanged nut (7) until the wheel shim is locked, tighten the locking screws (8) on the right fork shoe to prevent the wheel axle from turning and tighten the flanged nut at 40 Nm. Tighten the locking screws on the left fork leg at 12Nm. Loosen the locking screws on the right shoe again, remove the motorcycle from the stand, activate the front brake and force the fork down several times to align the rods. End by definitively tightening the locking screws on the right fork shoe at 12Nm.

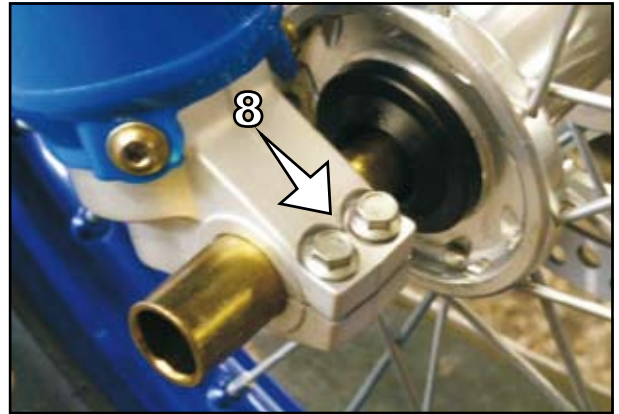

## ⚠ DANGER

- IF YOU DO NOT HAVE A DYNAMOMETRIC WRENCH WHEN MOUNTING, HAVE THE TIGHTENING TORQUE CHECKED AS SOON AS POSSIBLE IN A SPECIALISED TM WORKSHOP. A LOOSE WHEEL AXLE CAN CAUSE UNSTABLE DRIVING.
- AFTER HAVING MOUNTED THE FRONT WHEEL, REPEATEDLY ACTIVATE THE BRAKE LEVER UNTIL THE PAD ADHERES TO THE DISC AGAIN.
- THE BRAKE DISC MUST ALWAYS BE PERFECTLY CLEAN FROM OIL AND GREASE. ON THE CONTRARY, THE BRAKING EFFECT WOULD BE GREATLY REDUCED.

## DISASSEMBLY AND ASSEMBLY OF THE REAR WHEEL (ALL EXCEPT SMM)

Rest the motor cycle with the frame cradle on a stand, in a way that the rear wheel does not touch the ground. Unscrew the flanged nut (9) and, supporting the wheel, extract the wheel axle (10), remove the chain-tensioning slide (11), remove the chain from the sprocket, remove the caliper with its support and carefully extract the rear wheel from the swing arm. Pay attention to the thin wheel shim (sprocket side) and thick shim (brake side).

## ⚠ WARNING

- DO NOT ACTIVATE THE BRAKE PEDAL WHEN THE REAR WHEEL HAS BEEN DISASSEMBLED.
- ALWAYS POSITION THE WHEEL WITH THE BRAKE DISC UPWARDS TO PREVENT DAMAGE.
- WHEN THE WHEEL AXLE IS DISASSEMBLED THE WHEEL AXLE THREADS AND THE THREADS OF THE FLANGED NUT MUST BE WELL CLEANED. RE-GREASE THEM TO PREVENT SEIZING OF THE THREADS.

To assemble, insert the thin spacer (sprocket) into the hub, position the chain tensioners, insert the wheel into the swing arm and, supporting the wheel, position the caliper with its support and mount the chain onto the sprocket. Insert the axle from the sprocket side into half the wheel to permit positioning of the thick spacer (brake side). Finish inserting the axle, insert the chain-tensioner slide, screw the nut and tighten it at 80 Nm. Before tightening the flanged nut push the rear wheel forward until the chain tensioners are in contact with the heads of the adjusting screws.

## ⚠ DANGER

- IF YOU DO NOT HAVE A DYNAMOMETRIC WRENCH WHEN MOUNTING, HAVE THE TIGHTENING TORQUE CHECKED AS SOON AS POSSIBLE IN A SPECIALISED TM WORKSHOP. A LOOSE WHEEL AXLE CAN CAUSE UNSTABLE DRIVING.
- THE BRAKE DISC MUST ALWAYS BE PERFECTLY CLEAN FROM OIL AND GREASE. ON THE CONTRARY, THE BRAKING EFFECT WOULD BE GREATLY REDUCED.
- AFTER HAVING RE-ASSEMBLED THE REAR WHEEL ALWAYS ACTIVATE THE BRAKE PEDAL SO THAT THE PADS ADHERE TO THE DISC AGAIN.
- TIGHTEN THE FLANGED NUT WITH THE ESTABLISHED TIGHTENING-TORQUE. A LOOSE WHEEL AXLE CAN LEAD TO UNSTABLE DRIVING.

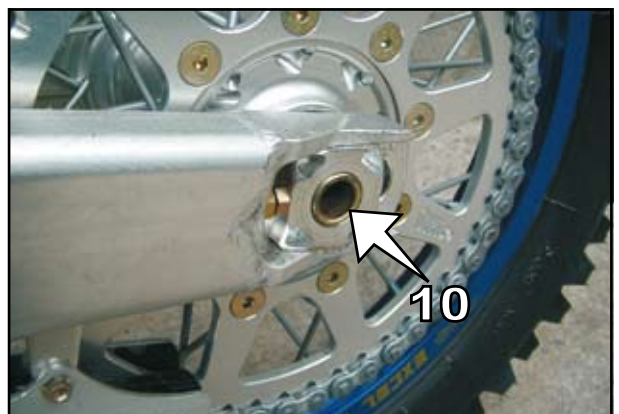

## DISASSEMBLY AND ASSEMBLY OF REAR WHEEL (SMM)

Rest the motorcycle with the frame cradle on a stand, in a way that the rear wheel does not touch the ground. Cut the safety binding (1), slide out the clasp (2) and unscrew the wheel nut M50x1.5 (3). Pay attention to the conical shim (4) placed between the nut and ring. Extract the wheel carefully.

### ⚠ WARNING

- WHEN THE WHEEL NUT IS DISASSEMBLED, THE SHAFT AND NUT THREADS MUST BE CLEANED CAREFULLY. RE-GREASE THEM TO PREVENT SEIZING OF THE THREADS.

To assemble, proceed in the opposite direction, tightening the M50x1.5 wheel nut at 185 Nm. Remount the clasp and re-make the safety binding.

### ⚠ DANGER

- DO NOT FORGET TO CARRY OUT THE SAFETY BINDING AT THE ENDS OF THE CLASP
- IF YOU DO NOT HAVE A DYNAMOMETRIC WRENCH WHEN MOUNTING, HAVE THE TIGHTENING TORQUE CHECKED AS SOON AS POSSIBLE IN A SPECIALISED TM WORKSHOP. A LOOSE WHEEL AXLE CAN CAUSE UNSTABLE DRIVING.
- THE BRAKE DISC MUST ALWAYS BE PERFECTLY CLEAN FROM OIL AND GREASE. ON THE CONTRARY, THE BRAKING EFFECT WOULD BE GREATLY REDUCED.
- AFTER HAVING RE-ASSEMBLED THE REAR WHEEL ALWAYS ACTIVATE THE BRAKE PEDAL SO THAT THE PADS ADHERE TO THE DISC AGAIN.

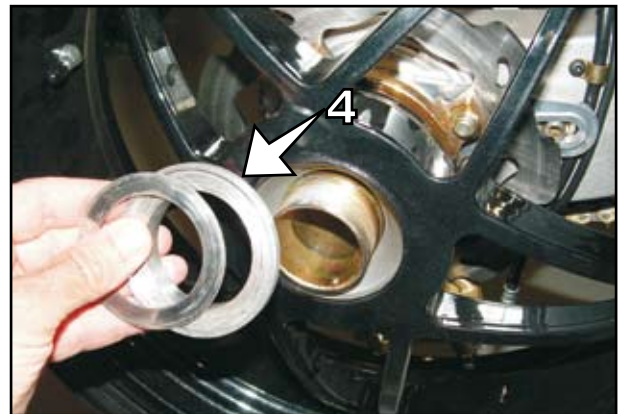
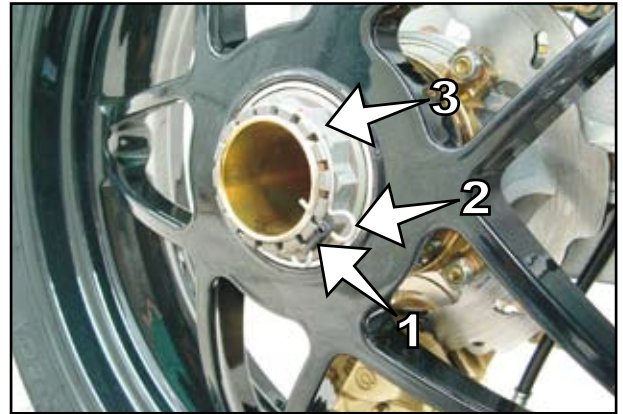

## CHECK SPOKE TENSION

Correct tension of the spokes is very important for the stability of the wheel and therefore safety on the road. An insufficiently tight spoke leads to unbalancing of the wheel and in brief time loosening of other spokes. Regularly check the tension of the spokes, particularly on new motorcycles. Briefly hit every spoke with the end of a screwdriver (see photo): the spoke should produce a clear sound. Hollow sounds mean loose spokes. In this case you must have the spokes adjusted in a specialised workshop. The wheel must also be centred.

### ⚠ DANGER

- IF YOU CONTINUE TRAVELLING WITH INSUFFICIENTLY TIGHT SPOKES, THEY MAY TEAR CAUSING PROBLEMS OF INSTABILITY.
- EXCESSIVELY TIGHT SPOKES MAY TEAR DUE TO LOCAL OVERLOADING.



## TYRES, TYRE PRESSURE

The type, the state and the pressure of the tyres condition the motorcycle's behaviour on the road and they must be checked before every journey.

- The dimension of the tyres is indicated in the technical data and in the registration paper.
- The state of the tyres must be controlled before every journey. Check the tyres by verifying that they are not cut, have nails or other sharp objects pushed into them. Regarding the minimum depth of the profile, respect the regulations in force in your country. We recommend that the tyres are changed at the latest, when the profile has reached a depth of 2 mm.
- The tyre air pressure must be checked regularly when the tyres are "cold". Correct adjustment of the pressure guarantees optimal comfort when travelling and maximum duration of the tyre.

## TYRE PRESSURE

	FRONT	REAR
Off-road	1.1 bar	1.1 bar
Road, rider only	1.7 bar	1.7 bar

### **⚠ DANGER**

- HAVE EXCLUSIVELY TYRES OF APPROVED TYPE AND DIMENSIONS MOUNTED ON YOUR VEHICLE AND HOWEVER ESTABLISHED BY TM. DIFFERENT TYRES CAN NEGATIVELY CONDITION THE BEHAVIOUR OF THE MOTORCYCLE ON THE ROAD AND BE THE CAUSE OF FINES ENVISIONED BY THE REGULATIONS IN FORCE IN YOUR COUNTRY .
- TO GUARANTEE YOUR SAFETY AND THAT OF OTHERS, DAMAGED TYRES MUST BE REPLACED IMMEDIATELY.
- EXCESSIVELY WORN TYRES NEGATIVELY CONDITION THE BEHAVIOUR OF THE MOTORCYCLE, MOST OF ALL ON WET SURFACES.
- INCORRECT PRESSURE LEADS TO ANOMALOUS WEAR AND OVER-HEATING OF THE TYRE.

## CHECK ADJUSTMENT OF MAGNETIC SENSOR FOR TACHOMETER (A)

In all the versions the magnetic sensor is located on the rear wheel.

**END/SMR** - The distance between the head of the screws (2) and the sensor (1) must be 2-4mm. If not, the tachometer may not work properly. The distance of the sensor is adjusted by the shim (3). Do not remove it, otherwise the sensor may hit the screws and get damaged.

**SMM** - The distance between the brake disc side face (4) and the sensor (1) must be 2-4mm. If not, the tachometer may not work properly. The distance is adjusted by the shim (3). Do not remove it, otherwise the sensor may hit the disc side face (4) and get damaged.

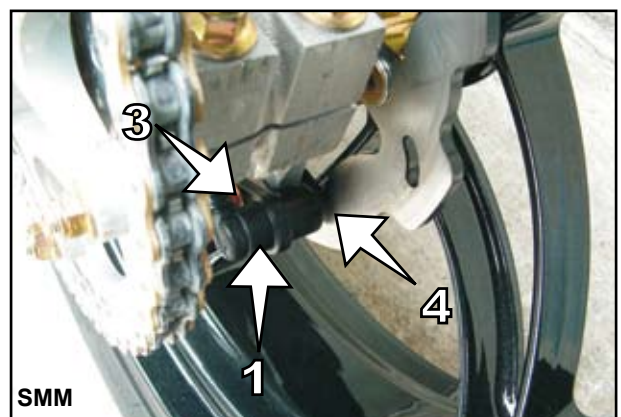
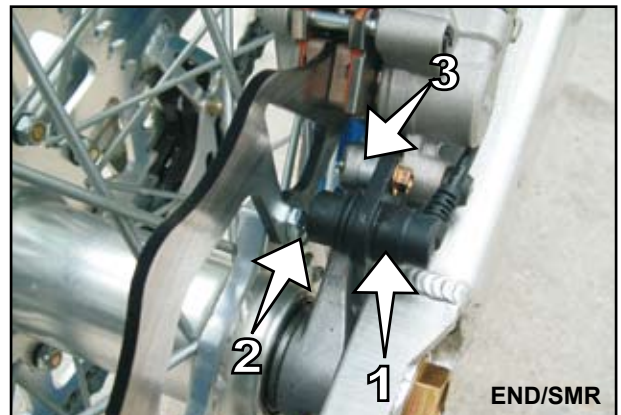

## BATTERY (SMR AND SMM)

The saddle must be removed to access the battery.  
 The battery does not require maintenance.  
 It is not necessary to check the level of the electrolyte or top-up with water.  
 The battery poles must be cleaned and, if necessary, slightly greased using grease that does not contain acids.  
**Battery disassembly:**  
 First remove the negative pole and then the positive pole from the battery.  
 Disconnect the elastic stripes (1).  
 Remove the battery.  
 When assembling the battery, place it with the poles pointing external part (see figure), first connect the positive pole and then the negative pole to the battery.



### **⚠ DANGER**

- IF FOR SOME REASON THE ELECTROLYTE (SULPHURIC ACID) SHOULD ESCAPE FROM THE BATTERY, BE VERY CAREFUL. THE ELECTROLYTE CAN CAUSE SERIOUS BURNS.
- ON CONTACT WITH THE SKIN, RINSE WELL WITH WATER
- IF DROPS OF THE ELECTROLYTE ENTER INTO THE EYES, RINSE FOR AT LEAST 15 MINUTES WITH WATER AND CONSULT A DOCTOR IMMEDIATELY.
- EVEN IF THE BATTERY IS SEALED, IT IS POSSIBLE THAT EXPLOSIVE GASES MAY COME OUT. KEEP THE BATTERY AWAY FROM SPARKS OR FLAMES.
- KEEP FAULTY BATTERIES AWAY FROM CHILDREN AND DISPOSE OF THEM IN THE CORRECT MANNER.



### **⚠ WARNING**

- THE CLOSURE STRIP MUST NOT BE REMOVED.

### **PRESERVATION:**

If the motorcycle is kept at a standstill for a long time, remove the battery and charge it. Keep it at a temperature of 0-35°C away from direct sunlight.

## BATTERY CHARGE

Install the battery in a low-power electronic buffer battery charger. A battery charge keeper is also suitable.

The instructions for charging are also given on the side of the battery.

### **⚠ WARNING**

- THE CLOSURE STRIP MUST NOT BE REMOVED, AS IT WOULD BE DAMAGED.
- TO RECHARGE, FIRST CONNECT THE BATTERY TO THE BATTERY CHARGER, THEN SWITCH THE BATTERY CHARGER ON.
- WHEN RECHARGING IN CLOSED SPACES, ENSURE GOOD VENTILATION. THE BATTERY PRODUCES EXPLOSIVE GASES DURING CHARGING.
- IF THE BATTERY IS CHARGED TOO LONG OR AT A TOO HIGH VOLTAGE, THE ELECTROLYTE WILL COME OUT THROUGH THE SAFETY VALVES. THE BATTERY THEREFORE LOOSES CAPACITY.
- POSSIBLY AVOID FAST CHARGE

	STANDBY	CYCLE
VOLT	13.5 - 13.8	14.4 - 15
MAX CURRENT	0.32 A	

**HALOGEN LIGHT (END)**
**LIGHT HEIGHT ADJUSTMENT**

The front light height can be adjusted. First you need to move the rubber stripes on the fork leg so as the light body sits horizontally, then you can turn the front screw (1) to adjust the light height.

Turn the screw clockwise to lift the light, anticlockwise to lower it.

**REPLACEMENT OF HEADLIGHT/POSITION LIGHT BULB**

Release both elastic stripes and move the light-holder mask forward.

**HEADLIGHT TWO-LIGHT BULB**

Disconnect the cable connector and remove the rubber protection (2).

Release the retainer and carefully extract the halogen bulb (3).

Reassemble the new bulb, the rubber protection and the connector.

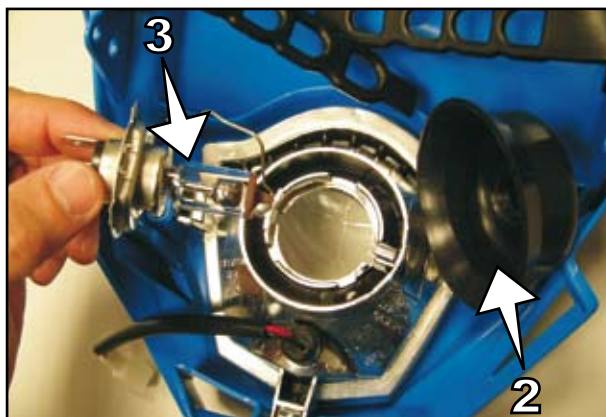
**POSITION BULB**

Disconnect the side connector, extract the bulb-holder (4) from the light body and change the bulb.

Reassemble the bulb-holder and the connector.

Reposition the light-holder mask and secure it with the rubber stripes.

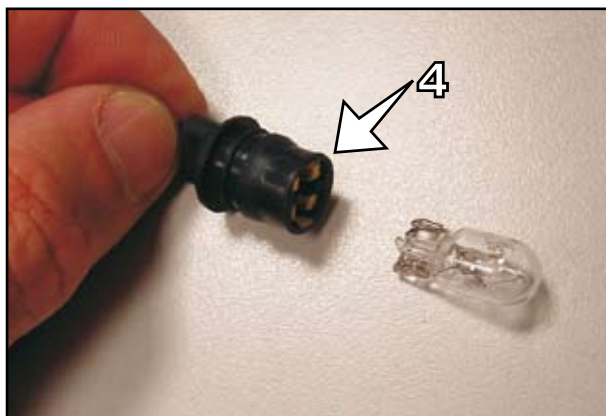
**⚠ WARNING**

NEVER TOUCH THE GLASS BULB, TO PREVENT LEAVING TRACES OF GREASE. TO BE SURE OF INSERTING THE ESTABLISHED BULBS, CONSULT THE "CYCLE PART TECHNICAL DATA" TABLE

**HALOGEN LIGHT (SMR)**
**LIGHT HEIGHT ADJUSTMENT**

The front light height can be adjusted. First you need to move the rubber stripes on the fork leg so as the light body sits horizontally, then you can turn the front screw (1) to adjust the light height.

Turn the screw clockwise to lift the light, anticlockwise to lower it.

**REPLACEMENT OF HEADLIGHT/POSITION LIGHT BULB**

Release both rubber stripes and move the light-holder mask forward.

**HEADLIGHT TWO-LIGHT BULB**

Disconnect the cables connector and remove the rubber protection (2).

Release the retainer and carefully extract the halogen bulb (3).

Reassemble the new bulb, the rubber protection and the connector.

**POSITION BULB**

Disconnect the side connector, extract the bulb-holder (4) from the light body and change the bulb. Reassemble the bulb-holder. Reposition the light-holder mask and secure it with rubber stripes.

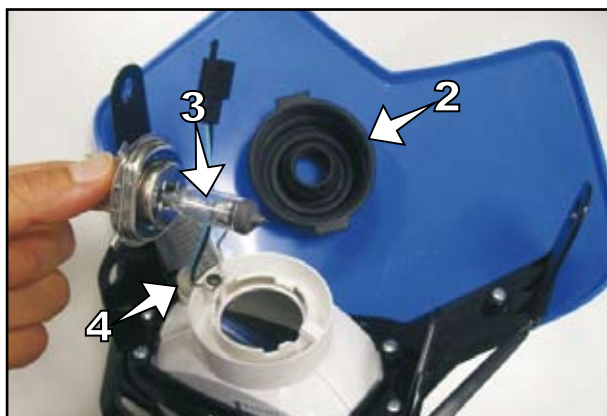
**⚠ WARNING**

NEVER TOUCH THE GLASS BULB, TO PREVENT LEAVING TRACES OF GREASE.

TO BE SURE OF INSERTING THE ESTABLISHED BULBS, CONSULT THE "CYCLE PART TECHNICAL DATA" TABLE



**CICLOPS HEADLIGHT (SMM)**
**REPLACEMENT OF HEADLIGHT/POSITION LIGHT BULB**

Release both of the elastic stripes and move the light-holder mask forward.

**HEADLIGHT BULB**

Disconnect the terminal, remove the cover (4) and the seal (5). Unscrew the screws (6) and remove the retainer (7). Loosen the Allen screw (8) and carefully extract the bulb (9).

Replace with an equivalent one, tighten the Allen screw again, remount the retainer in the correct position and lock with the screw, taking care to insert the engine stop eyelet terminal under the head of the screw.

Remount the cover with the seal and connect the terminal.

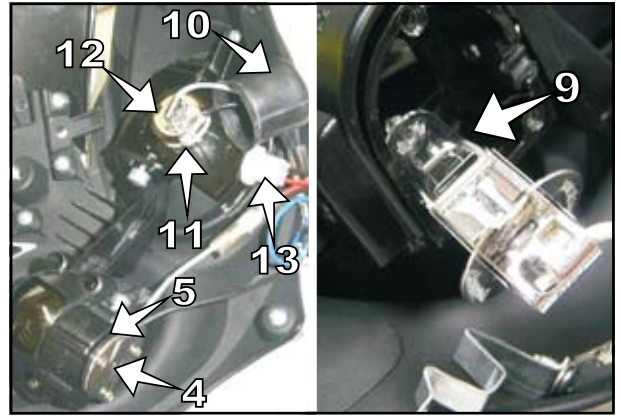
**HIGH BEAM BULB**

Remove the rubber protection (10), unscrew the screw (11) and carefully extract the bulb (12). Replace the bulb with an equivalent one.

Remount the retainer in the correct position and lock with the screw, taking care to insert the engine stop eyelet terminal under the head of the screw.

Reposition the rubber protection.

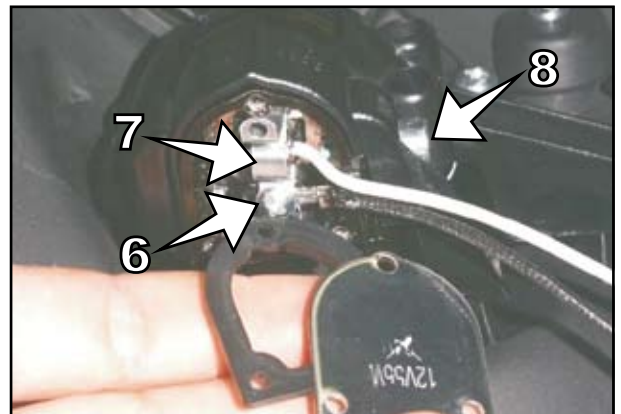
**POSITION LIGHT BULB**

Extract the bulb-holder (1) from the parabola, replace the bulb (2). Remount the bulb-holder.

Reposition the light-holder mask and fix it with the elastic stripes

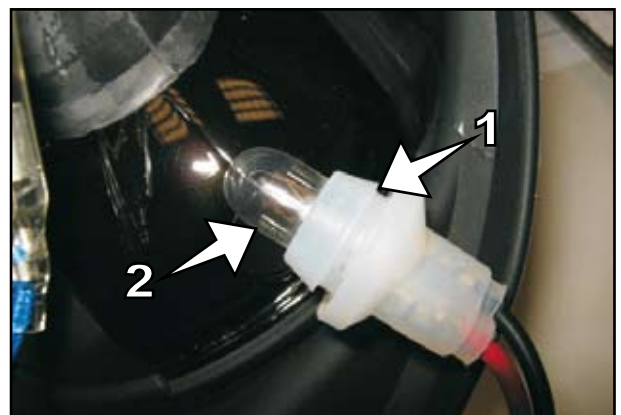
**⚠ WARNING**

NEVER TOUCH THE GLASS BULB, TO PREVENT LEAVING TRACES OF GREASE.

TO BE SURE OF INSERTING THE ESTABLISHED BULBS, CONSULT THE "CYCLE PART TECHNICAL DATA" TABLE

**LED REAR LIGHT (END)**

**REPLACEMENT POSITION LED/ STOP LED / NUMBER PLATE LED**

Unscrew the screws (1) and remove the rear light body after disconnecting the wires from the bike harness. Since the led light is a single part, you have to change it completely. Ask for the original spare part to an official TM Dealer.



**REAR LIGHT (SMR/SMM)**

**REPLACEMENT POSITION / STOP / NUMBER PLATE LIGHT BULB**

Unscrew the screws (2) and remove the cover (3). Replace the bulb with an equivalent one. Reassemble the cover and tighten the screws. The bulb is a two-light type and provides all the above functions.

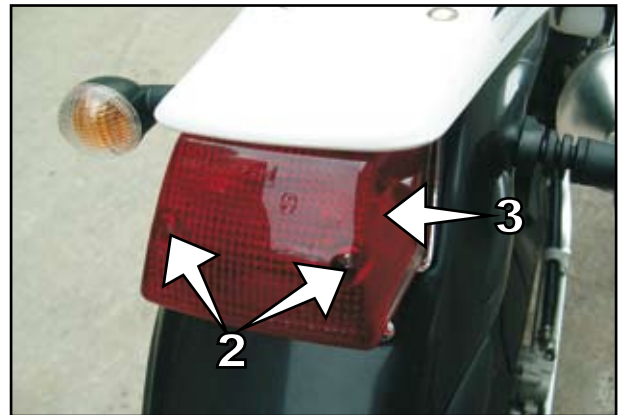

**DIRECTION INDICATOR LAMP (END/SMR/SMM)**

**REPLACEMENT OF BULB**

Unscrew the screws (4) and remove the cover (5). Replace the bulb with an equivalent one. Remount the cover and tighten the screws.

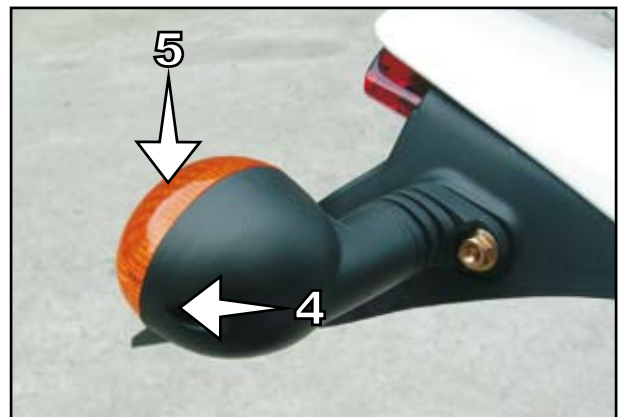

## COOLING

The water pump (1) housed in the engine induces forced circulation of the coolant liquid.

There is no thermostat in the system, therefore, when the engine is cold, it is important to moderate the number of revs. of the engine and speed. Proceed for at least 5 minutes at half throttle and at reduced pace to allow the engine to reach an adequate working temperature.

Cooling takes place thanks to the passage of air through the fins of the radiator, the lower the speed, the less the cooling effect. Dirty radiator fins also decrease the cooling effect.

The pressure caused by the high liquid temperature is adjusted by a valve on the radiator cap (2); it is possible to reach temperatures of 120°C without problems.

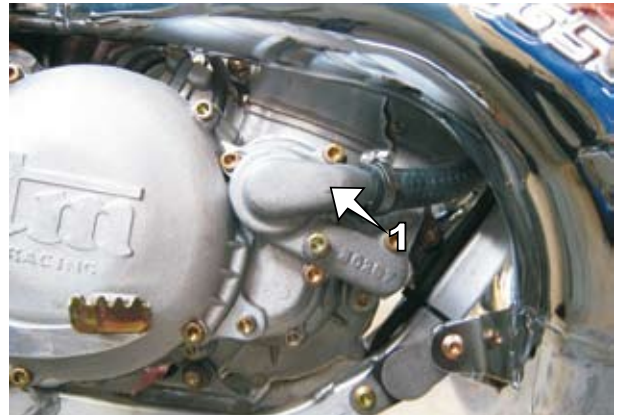

### **⚠ DANGER**

- CHECK THE LEVEL OF THE COOLANT LIQUID WHEN THE ENGINE IS COLD. IF YOU MUST REMOVE THE RADIATOR CAP WHEN THE ENGINE IS HOT, COVER IT WITH A CLOTH AND OPEN SLOWLY TO RELEASE THE PRESSURE. ATTENTION, BURNS HAZARD!
- DO NOT DISCONNECT THE RADIATOR HOSES WHEN THE ENGINE IS HOT. THE COOLANT LIQUID AND THE HOT STEAM THAT ESCAPE, MAY CAUSE SERIOUS BURNS.
- IF YOU ARE BURNED, PUT THE INTERESTED PART UNDER COLD RUNNING WATER.
- THE COOLANT IS TOXIC! THEREFORE PRESERVE IT OUT OF THE REACH OF CHILDREN.
- IF YOU SWALLOW COOLANT, SEEK MEDICAL ADVICE IMMEDIATELY.
- IF THE COOLANT HITS THE EYES, RINSE IMMEDIATELY WITH COLD WATER AND SEEK MEDICAL ADVICE.

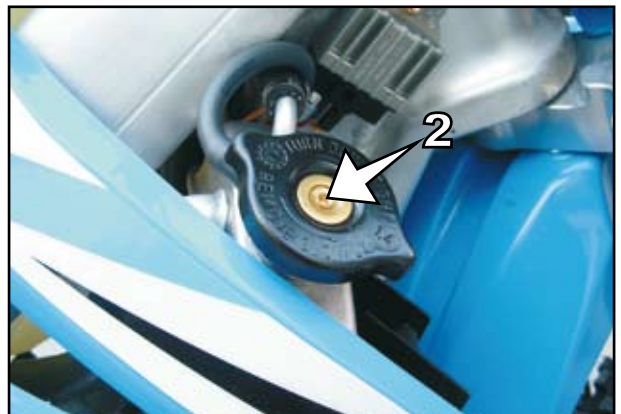

The coolant liquid is a mixture of antifreeze at 40% and water at 60%. The antifreeze protection limit must however be at least -25°C.

This mixture offers protection against freezing as well as a good protection against corrosion and therefore should not be replaced by pure water.

### **⚠ WARNING**

- AFTER THE COOLANT LIQUID HAS BEEN EMPTIED, WHEN RE-FILLING IT IS NECESSARY TO BLEED THE COOLING SYSTEM (SEE NEXT PAGE).
- ALWAYS USE GOOD QUALITY PRODUCTS TO PREVENT CORROSION OR FOAM.
- IN EXTREME WEATHER CONDITIONS OR IN STOP-AND-GO TRAFFIC, OVERHEATING MAY OCCUR. TO SOLVE THIS PROBLEM, AN ELECTRIC FAN KIT IS AVAILABLE FOR ALL MODELS WITH ELECTRIC STARTER (ASK AT YOUR TM AUTHORIZED DEALER).

## CHECK COOLANT LEVEL

When the engine is cold, the liquid must cover the radiator channels by at least 10 mm. If the circuit is emptied, fill it immediately and bleed.

### **WARNING**

WHEN THE COOLANT LIQUID HAS BEEN EMPTIED, WHEN RE-FILLING IT IS NECESSARY TO BLEED THE COOLING SYSTEM (SEE BELOW).



## EMPTYING, FILLING AND BLEEDING OF THE COOLING SYSTEM

The coolant liquid may be emptied by removing the screw (1) from the water pump cover on the right side of the engine. Prepare an adequate container to collect the liquid when it comes out. To empty the liquid, the filling cap must be opened. At the end, screw the emptying screw and tighten to 12 Nm.

To fill the cooling system, pour the amount of coolant liquid indicated in the "Engine Technical Data" Table, through the inlet. Close the radiator cap and start-up the engine for a few seconds. Re-open the cap and check the level: add more liquid if necessary.

After a brief journey, check the level of coolant liquid again.

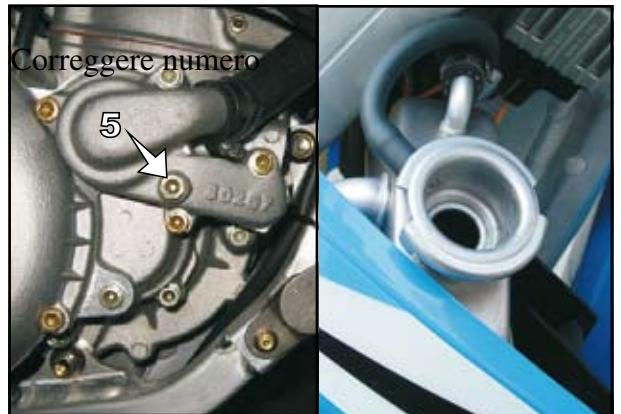

## REPLACEMENT OF EXHAUST SILENCER PACKING MATERIAL

The aluminium silencers are filled with acoustic insulating material (fibreglass) to limit motorcycle noise. Because of high temperatures reached by the exhaust gases, the fibreglass tends to burn, leading to a decrease in the effect of noise absorption and also causing a decrease in power. To replace the fibreglass, disassemble the silencer from the motorcycle frame, remove the rivets that support the front cap and slide the cap and the wool to be replaced out.

Before dismantling you are advised to mark with a pen the points between the slotted tube and silencer so that you'll be able to put them together again properly later on. Slide the fibreglass cartridge on the punched pipe and push it all into the silencer. Hold the clamp and fasten with rivets.

The length of fibreglass cartridge is 43 cm.



### **DANGER**

WHEN THE ENGINE IS RUNNING THE EXHAUST SYSTEM BECOMES VERY HOT. ONLY START TO WORK ON THE EXHAUST SYSTEM WHEN IT HAS COOLED DOWN, TO PREVENT BURNS.

To ease mounting of the silencer, grease the ends of the pipes. Also fix the retaining spring between the pipe and the silencer. When the engine is started-up it might generate some smoke from the previously greased parts. This is caused by the high temperature that melts the grease.

### **WARNING**

REPLACE THE FIBREGLASS CARTRIDGE WITH A NEW ONE OF THE SAME BASIC WEIGHT OR BOUGHT AT A TM AUTHORIZED DEALER.

## CLEANING THE AIR FILTER

A dirty air filter jeopardises the filtering of air, reducing engine power and increasing fuel consumption. In some cases, the dust can even reach the engine causing serious damage. For this reason, maintenance of the filter should be carried out regularly.

Remove the seat to access the filter and lift the control unit support. To remove the filter, unscrew the finger screw positioned at the centre of the filter and carefully slide it the filter out of its case.

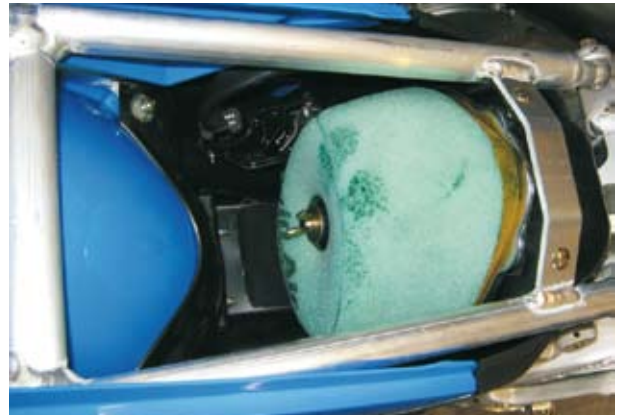

### **⚠ WARNING**

- DO NOT CLEAN THE FOAM FILTER WITH FUEL OR KEROSENE, WHICH CAN CORRODE IT. FOR CORRECT MAINTENANCE OF THE FOAM FILTER, USE THE RELEVANT PRODUCTS ON THE MARKET FOR CLEANING AND LUBRICATION.
- NEVER START-UP THE MOTORCYCLE WITHOUT THE AIR FILTER. THE INFILTRATION OF DUST AND DIRT CAN CAUSE DAMAGE AND INCREASE WEAR.

Wash the filter carefully using a special liquid detergent and dry well: squeeze the filter slightly but do not wring it. Also clean the filter case and check that the rubber manifold that connects the carburetor to the filter case is integral and positioned correctly.

Remount the air filter, positioning it correctly on the rest surface, taking care that edges of the filter are not raised or not adherent with the rest surface.

Remount the finger screw and tighten it adequately.



## ADJUSTMENT OF CLUTCH LEVER BASIC POSITION

With this option, to adjust the clutch lever distance from the handlebar grip (see maintenance operation), you have to turn the adjustment knob (1).

Rotate clockwise to increase the distance or counterclockwise to decrease the distance.



## CHECK HYDRAULIC CLUTCH FLUID LEVEL

The reservoir is part of the clutch pump positioned on the handlebar. To check the fluid level remove the screws (2) and the cap (3) together with the rubber seal (4). With the reservoir in a horizontal position, the fluid should not be below the centreline or above the top threshold.

### **⚠ WARNING**

- FOR THE HYDRAULIC COMMAND OF THE CLUTCH, TM USES DOT4 BRAKE FLUID, NEVER USE DOT5 OR OTHER.
- DO NOT ALLOW BRAKE FLUID TO COME INTO CONTACT WITH PAINTED PARTS. THE BRAKE FLUID CORRODES THE PAINT !
- ONLY USE CLEAN BRAKE FLUID OUT OF HERMETICALLY-SEALED CONTAINERS.



## BLEEDING THE HYDRAULIC CLUTCH

For bleeding the hydraulic clutch, remove the cap of the pump on the handlebar. Connect the suction machine to the bleeding nipple (5) of the clutch cylinder on the engine. Switch on the suction machine and loosen the nipple. Continue until no more air escapes from the nipple, only oil. Tighten the nipple. Disconnect the suction device. During the operation control that the level in the clutch pump reservoir is always sufficient and prevent the pump from taking up air. If necessary, top-up with DOT4 brake fluid.

### ⚠ WARNING

- FOR THE HYDRAULIC COMMAND OF THE CLUTCH, TM USES DOT4 BRAKE FLUID, NEVER USE DOT5 OR OTHER.
- DO NOT ALLOW BRAKE FLUID TO COME INTO CONTACT WITH PAINTED PARTS. THE BRAKE FLUID CORRODES THE PAINT !
- ONLY USE CLEAN BRAKE FLUID OUT OF HERMETICALLY-SEALED CONTAINERS.

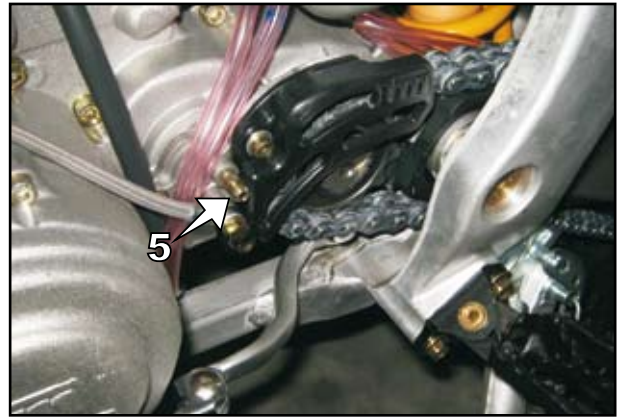

## THROTTLE CABLE COMMAND ADJUSTMENT

The throttle command should always have a free play of 3-5 mm. Moreover, when the engine is idling, the revs must not vary when steering as far as possible to the left and to the right. To adjust the play, push the protection hood (6) backwards. Loosen the counter-nut (7) and unscrew or screw the register (8). By screwing, the free play increases. By unscrewing, the free play decreases.

Tighten the counter-nut and check the smoothness of the the throttle command handlebar grip.

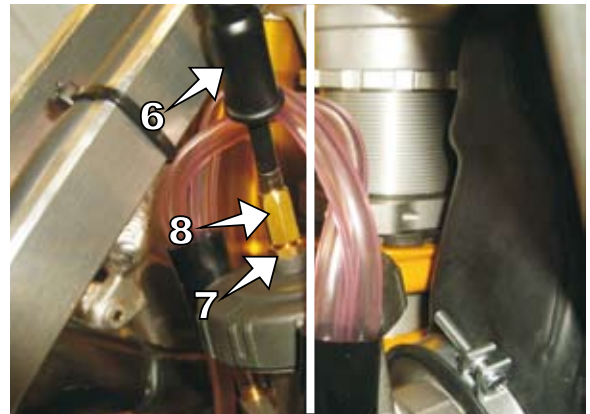

## NOTES ON THE CARBURETTOR

The carburetor is calibrated at sea level and at a temperature of 20° using premium-grade fuel (RON95, unleaded) mixed with 1:30 specific 2T oil.

The only changes that you might need to make are to the main jet, idle jet and jet needle; changes to other parts of the carburetor are usually pretty minor.

### ATTENTION

High altitude or high temperature conditions require a leaner carburetor setting

Low altitude or low temperature conditions require a richer carburetor setting

### ⚠ WARNING

- 2-STROKE TM ENGINES REQUIRE A MIXING RATIO OF 1:30 WITH OIL, SO YOU SHOULD ADD 33 CC (OR ML) OF OIL FOR EACH LITRE OF FUEL. DO NOT USE FUEL WITH AN OCTANE NUMBER UNDER 95 AS THIS COULD DAMAGE THE ENGINE.
- USE HIGH QUALITY 2T ENGINE OIL. THE BEL-RAY H1-R IS THE ONLY ONE TM APPROVES, USES AND RECOMMENDS.
- YOU MUST PUT IN THE CORRECT AMOUNT OF OIL: LESS OR OUT-OF-DATE OIL COULD CAUSE THE ENGINE TO WEAR OUT QUICKLY AND, IN EXTREME CASES, RESULT IN IRREPARABLE DAMAGE. AN EXCESSIVE AMOUNT OF OIL, INSTEAD, CAN CAUSE MORE FUMES THAN NORMAL, AND FOUL THE SPARK PLUG AND EXHAUST VALVE.

## DEFINITION AND USE OF A CARBURETOR FOR A 2-STROKE ENGINE:

- RICH MIXTURE: the amount of fuel is too high in relation to the amount of air.
- LEAN MIXTURE: there is not enough fuel in relation to the amount of air.

### OPERATION AT IDLING phase 1

The carburetor is running with the throttle valve closed. The mixture is regulated by the air adjustment screw (1) and idle adjustment screw (2). You should make the necessary adjustments with the engine hot.

### OPERATION WITH THROTTLE VALVE OPENING phase 2

The throttle valve is open; mixture is controlled by the idle jet and shape of the throttle valve.

### OPERATION WITH THROTTLE VALVE PARTIALLY OPEN (PARTIAL CAPACITY) phase 3

The throttle valve is partially open. In this case the mixture is regulated simply by the position (notch) and the shape of the jet needle. It is determined at low speed by the idle adjustment screw and at high speed by the main jet.

### OPERATION WITH GAS THROTTLE VALVE FULLY OPEN (MAX CAPACITY) phase 4

In this case the mixture is regulated simply by the main jet and the jet needle.

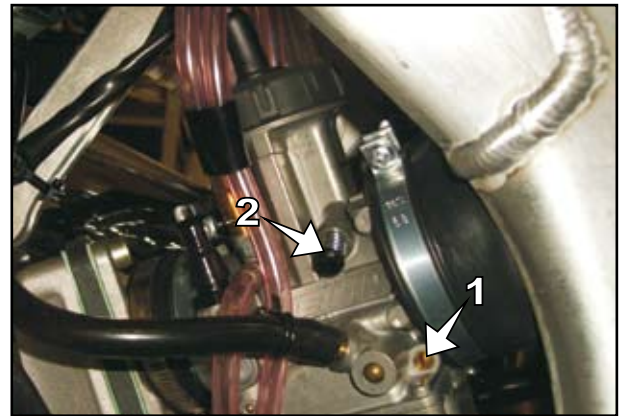

## CARBURETOR ADJUSTMENTS

### OPERATION AT IDLING SPEED

Turn the idle adjustment screw to gently adjust engine range – clockwise to increase, anticlockwise to decrease. Make sure the engine speed is as smooth and constant as possible.

### OPERATION WITH THROTTLE VALVE OPENING

If you have properly regulated the idling speed and partial capacity but the engine rumbles, emits excessive fumes and reaches full speed brusquely revving faster than expected, it could be a too rich mixture or a too high fuel level in the float bowl

### OPERATION WITH THROTTLE VALVE PARTIALLY OPEN (PARTIAL CAPACITY)

If the engine runs on a four-stroke cycle or with decreased power during acceleration with the throttle valve partially open, then you will need to lower the jet needle raising the clip by 1 groove.

If instead the engine rattles, especially during acceleration and at high speeds, then you will need to raise the jet needle.

Alternatively, if you encounter similar problems while travelling at low speed and at partial capacity, you need to check whether the engine has flooded and set a leaner mixture, or set a richer one if the engine is rattling.

### OPERATION WITH THROTTLE FULLY OPEN (MAX CAPACITY)

If after a while at full gas the insulating part of a new plug (the ceramic part around the electrodes) appears particularly bright or white, you will need to replace the main jet with a richer one.

If instead the insulating part of the plug appears dark or blackened, you will need to replace the main jet with a leaner one.

Contact your TM agent for selecting needles, main and idle jets or any other part of the carburetor.

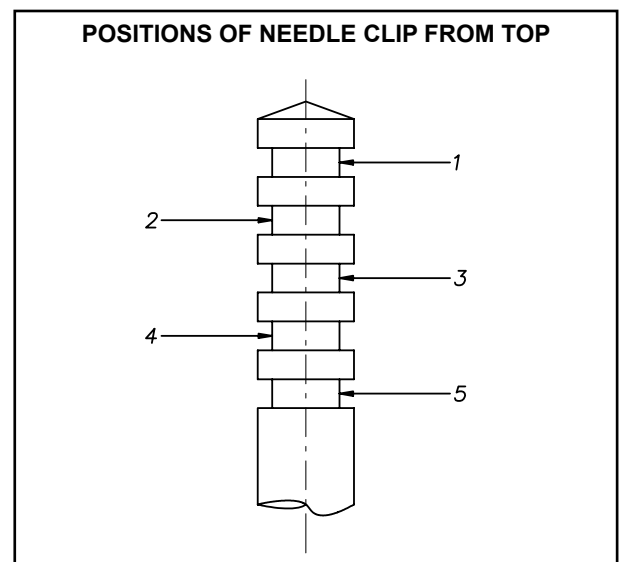
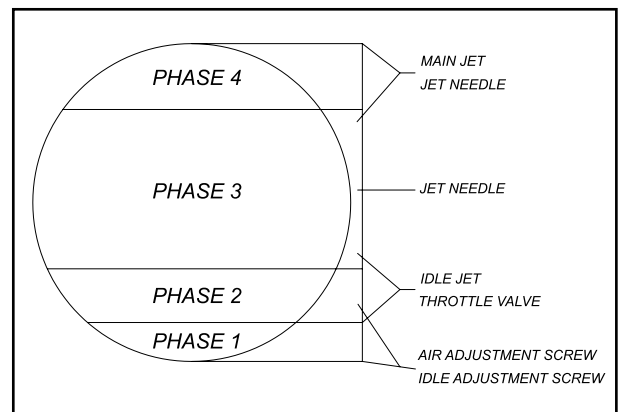

### CHECK FUEL LEVEL (FLOAT HEIGHT) (A)

Disassemble the carburetor and remove the float bowl. Turn the carburetor upside-down and keep it inclined so that the float rests on the needle valve but does not compress the spring with its weight.

In this position, use a gauge to measure the distance between the apex of the float body and the float bowl surface on the carburetor body (see image). Refer to the technical data for the correct value for your motorcycle.

If necessary, adjust the height by slightly bending the float adjustment plate (1).

If possible, also check the tightness and the state of wear of the needle valve cone: if in doubt replace the valve and brass seat.

Mount the float bowl, mount the carburetor and adjust the idle speed.

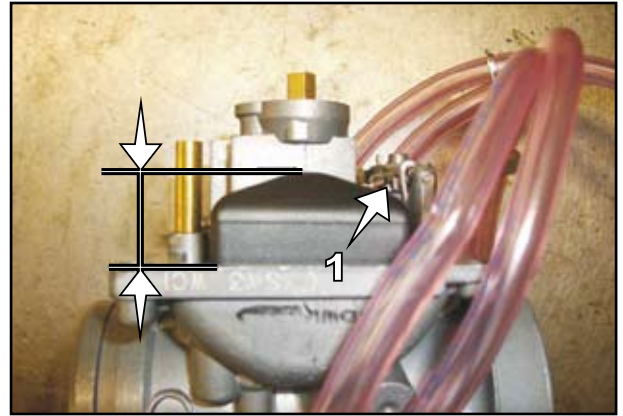

### BASIC INDICATIONS REGARDING CARBURETOR WEAR

The throttle valve, jet needle and the float needle valve are subject to great wear caused by engine vibration. As a consequence the carburetor may malfunction (e.g. enriching of the mixture). These parts must therefore be controlled after 100 hours.

### EMPTYING THE CARBURETOR FLOAT BOWL

After washing or driving in wet environments (watercourses, etc.) the carburetor float bowl should be emptied to remove any water that may have entered. Water in the float bowl causes working problems. Carry this operation out when the engine is cold. Close the fuel tap and place a container underneath the carburetor to collect the fuel coming out. Now open the screw (1) to empty the fuel and water. Re-close the screw, open the fuel tap and control tightness of the system.

#### **⚠ DANGER**

- THE FUEL IS HIGHLY INFLAMMABLE AND TOXIC. HANDLE THE FUEL WITH CARE. NEVER CARRY OUT OPERATIONS ON THE FUEL SYSTEM NEAR TO FLAMES OR CIGARETTES.
- ALWAYS ALLOW THE ENGINE TO COOL. USE A CLOTH TO REMOVE ANY OVERFLOWING FUEL. MATERIALS IMPREGNATED WITH FUEL ARE ALSO HIGHLY INFLAMMABLE. IF YOU SWALLOW FUEL OR IT COMES INTO CONTACT WITH THE EYES, CONSULT A DOCTOR IMMEDIATELY.
- DISPOSE OF FUEL ACCORDING TO THE REGULATIONS ENVISIONED IN YOUR COUNTRY.





## CHECK TRANSMISSION OIL LEVEL

You should check the level of the transmission oil with the engine at standstill but while it is still warm. Park the vehicle on level ground and keep it vertical (not on its side stand).

Remove the cap at the top (1) and the screw on the right-hand side (2).

The correct level is determined by the screw (2).

If no transmission oil drips out of the latter then you will need to top up the level through the cap (1). If instead some oil does drip out, this means there is plenty of oil inside and you should wait until the oil stops dripping out and reaches the level of the hole.

You are advised to use the same type of transmission oil already in the engine.

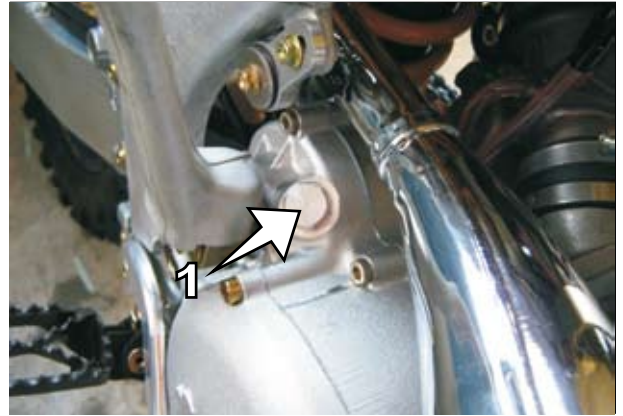

### **⚠ WARNING**

LOW OIL LEVEL, LOW QUALITY OIL, MAINTENANCE INTERVALS LONGER THAN THOSE ESTABLISHED, CAUSE SERIOUS DAMAGE TO THE ENGINE

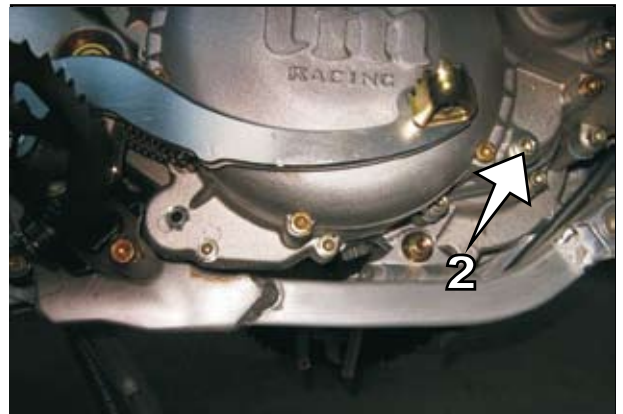

## TRANSMISSION OIL

TM use and recommended Bel-Ray Gear Saver SAE 80W.

### **⚠ WARNING**

LOW OIL LEVEL, LOW QUALITY OIL MAINTENANCE INTERVALS LONGER THAN THOSE ESTABLISHED, CAUSE SERIOUS DAMAGE TO THE ENGINE.

## CHANGE TRANSMISSION OIL (A)

### **⚠ WARNING**

WHEN CHANGING THE OIL, CLEAN THE MAGNET OF THE OIL DRAIN BOLT

The oil must be changed with the engine at working temperature.

### **⚠ DANGER**

THE ENGINE AT WORKING TEMPERATURE AND THE OIL INSIDE ARE VERY HOT - PAY ATTENTION, BURNS HAZARD.

Position the motorcycle on a flat surface, loosen and unscrew the cap (1) positioned on the lower face of the engine and allow the oil to flow into a container.

### **BEWARE OF HOT OIL!**

Clean the cap and incorporated magnet well. After the oil has flowed out completely, clean the sealing face, remount the cap together with the seal and tighten at 20 Nm. Replace the seal if it is damaged.

Quantity of oil after replacement: 500-550 cc

Quantity of oil after a complete engine overhaul: 600 cc

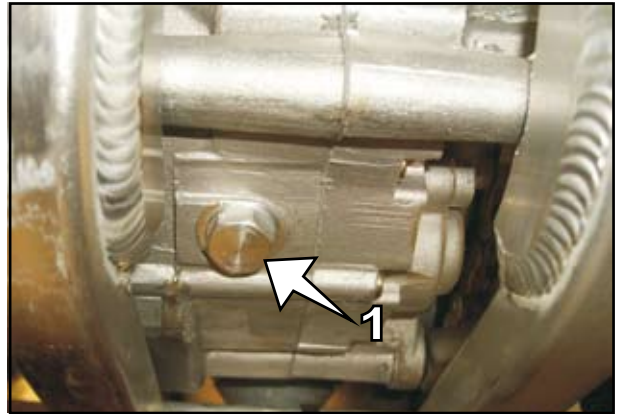

## INSPECTION OF THE REED VALVE

The reed valve, situated between the cylinder and the manifold, should be inspected whenever the engine is serviced. Remove the carburettor and manifold, and take out the reed valve; check the carbon parts are not damaged.



# TROUBLESHOOTING

If you have the envisioned maintenance operations carried out on your motorcycle, you will have very few problems. If, however, a problem does occur, please look for it in the following table and try to solve it. Please note that a lot of the operations cannot be carried out without the help of technicians . If in doubt, please contact an authorised TM dealer.

PROBLEM	CAUSE	SOLUTION
<b>THE ENGINE DOES NOT START</b>	The motorcycle hasn't been used for a while, therefore the old fuel has remained in the carburetor bowl	The volatile fuel components evaporate easily. If the motorcycle has not been used for more than 1 week, the old fuel should be emptied from the carburetor bowl. When the bowl has been filled with fresh fuel, the engine will start immediately.
	Fuel supply interrupted	Disconnect the fuel hose from the carburetor, place it in a container and open the fuel tap, - if fuel escapes, clean the carburetor - if fuel does not escape, control the tank vent pipe or clean the fuel tap
	Engine flooded	Use the "by-pass" command as explained in the "Operating controls" chapter.
	Spark plug blackened or wet	Clean and dry the spark plug or replace it.
	Incorrect spark plug electrodes gap	Adjust the gap between the electrodes as shown in the tables
	Spark plug cover or spark plug damaged	Slide off the spark plug cover, unscrew the spark plug, put the cover back onto the spark plug and, gripping the cover, keep the threaded part of the spark plug in contact with the head of the engine. Turn the engine with the electric starter or pedal, a spark should appear between the electrodes of the spark plug - if the spark plug does not produce a spark, it must be replaced - if there is still no spark, remove the spark plug cover from the H.T. cable coming from the coil, hold it at a distance of about 5 mm from the head and operate the starting system - if there is a spark, replace the spark plug cover - if there is still no spark, check the ignition system
	Oxidised CDI unit, pickup or coil connectors	Remove the saddle, the left side panel and the fuel tank, clean the connectors and treat them with a contact spray.
	Water in the carburetor or clogged jets	Disassemble and clean the carburetor

<b>PROBLEM</b>	<b>CAUSE</b>	<b>SOLUTION</b>
<b>THE ENGINE WILL NOT RUN AT IDLE SPEED</b>	Clogged idle speed jet	Disassemble the carburetor and clean the jet
	Altered idle speed adjustment screws	Adjust the idle speed screws
	Damaged spark plug	Replace the spark plug
	Faulty Ignition system	Have the ignition system checked
<b>THE ENGINE DOES NOT REACH FULL SPEED</b>	The fuel overflows because the level is adjusted too high or the float needle valve is dirty or worn	Disassemble the carburetor and check the height of the float and the state of the needle valve, as described in the "Frame and Engine Maintenance" chapter
	The carburetor jets are loose	Tighten the jets
	The ignition timing is not correct	Have the ignition timing checked
<b>POOR ENGINE POWER</b>	Fuel supply partially interrupted or dirty carburetor	Clean and check the fuel circuit and the carburetor
	Float not leakproof	Replace the float
	Air filter very dirty	Clean or replace the air filter, contact a specialised workshop
	Exhaust system not leakproof, deformed or fibreglass in the silencer packing damaged	Check the faulty parts on the exhaust system, replace the fibreglass in the silencer
	The ignition timing is not correct	Have the ignition timing checked
<b>ENGINE MISFIRINGS OR BACKFIRES FROM THE CARBURETOR</b>	Fuel missing	Clean and check the fuel circuit and the carburetor
	Air leaks in the intake manifold	Check the rubber manifolds between the filter case and the carburetor and between the carburetor and head and tighten the clamps
<b>THE ENGINE OVERHEATS EXCESSIVELY</b>	There is not enough fluid in the cooling system	Top-up with coolant fluid (see chapter "Frame and engine maintenance"), check for the system good sealing.
	Uninsufficient ventilation	Go on riding with half throttle and not too slow to allow the air flow through the radiators (it is possible to adopt an electric fan as optional)
	Air in the cooling system	Bleed the cooling system
	The radiator fins are very dirty	Clean the fins with a smooth water jet
	Presence of foam in the cooling system	Change the coolant fluid with new one, using premium quality antifreeze
	Bent radiator hose	If possible cut the hose a little shorter or replace it.
<b>EXCESSIVE TRANSMISSION OIL CONSUMPTION</b>	Leaking from the external seals	Check for the external seals
	Leaking from the internal seal between crankshaft and transmission	Have the internal seal checked by a TM authorized workshop
<b>ALL OF THE BULBS BLOW UNEXPECTEDLY</b>	The regulator is damaged	Remove the saddle and tank and check the connections of the voltage regulator. Have the regulator checked in a specialised TM workshop
<b>LIGHTS, HORN AND INDICATORS DO NOT WORK</b>	The lights cable fuse is burned out	Remove the left side panel and replace the lights cable 7.5A fuse

# CLEANING

Clean the motorcycle regularly in a way to maintain the surface of the plastic parts in good condition. To do this, it is advised to use hot water with a detergent and sponge. Most of the dirt can be removed using weak water jets.

## **WARNING**

NEVER CLEAN THE MOTORCYCLE WITH HIGH PRESSURE CLEANING DEVICES OR WITH STRONG JETS OF WATER! BECAUSE OF THE HIGH PRESSURE THE WATER COULD REACH THE ELECTRICAL PARTS, CONNECTORS, FLEXIBLE CABLE COMMANDS, BEARINGS, THE CARBURETOR ETC... AND CAUSE FAULTS OR PREMATURE BREAKAGE OF THESE PARTS.

- Before washing, close the exhaust pipe rear end to prevent water from entering.
- Normal soaps, found on the market, should be used to clean the motorcycle. Particularly dirty parts should be cleaned using a brush.
- After having rinsed the motorcycle well, using a weak jet of water, dry using compressed air and a cloth. Empty the carburetor bowl. Immediately after, make a brief journey until the engine has reached the normal working temperature and at this point activate the brakes. Because of the heat, the water that is left in the unreachable points and on the brakes will evaporate.
- After the motorcycle has cooled down, oil and grease all motion parts and bearings. Treat the chain with an appropriate spray. Also oil the fuel tap.
- To prevent faults in the electric system, treat the emergency shutdown button, the engine stop button, the light switch and the connectors with contact spray.

# PRECAUTION FOR WINTER USE

If the motorcycle is also used in winter it is necessary to consider the salt on the roads and appropriate countermeasures must be taken against the salt aggressiveness.

- The motorcycle must be cleaned well after use and left to dry.
- Treat engine, carburetor, swing arm and all other bright or galvanised components (except brake disc) with wax-based anti-corrosives.

## **DANGER**

**PREVENT CONTACT OF THE ANTICORROSIVE WITH BRAKE DISCS. THIS CAUSES GREAT REDUCTION IN THE BRAKING EFFECT.**

## **WARNING**

AFTER TRAVELLING ON ROADS WHERE SALT HAS BEEN SPREAD, WASH THE MOTORCYCLE WELL WITH COLD WATER AND LEAVE IT TO DRY.

# STORAGE

If the motorcycle is not to be used for a long time, take the following measures:

- Clean the motorcycle well (see CLEANING chapter)
- Change the engine oil and oil filter cartridge, clean the net filter (old oil contains dangerous impurities).
- Check the antifreeze and the quantity of the coolant.
- Warm the engine up again, close the fuel tap and wait until the engine stops. Successively open the carburetor bowl empty screw to empty the remaining fuel.
- Disassemble the spark plug and pour into the plug hole 5 cc of oil. Activate the kickstart pedal 10 times to distribute the engine oil onto the walls of the cylinder and then remount the spark plug.
- Empty the fuel tank, collecting the fuel in an appropriate container.
- Adjust tyre pressure.
- Grease bearings or command lever supports, footrests, etc. and also the chain. Disassemble the battery and charge it (see BATTERY chapter). Store it disassembled from the motorcycle.
- The place of storage should be dry and not subject to large temperature changes.
- Cover the motorcycle with a sheet or cover that allows air to pass. Do not use materials that do not allow the passage of air, as humidity would not be able to escape and could cause oxidation.

## **START-UP AFTER SEASONAL PAUSE**

- Mount the charged battery (pay attention to polarity)
- Fill the tank with new fuel
- Control the motorcycle as before any start-up (see "Instructions for use" chapter) - Make a short inspection trip.

**WARNING:** Before storing the motorcycle for the season, check functioning and wear of all components. If maintenance operations, repairs or modifications are necessary, it is a good idea to have them carried out during the winter time (less busy workshops). In this way it is possible to avoid long waits in the workshop at the beginning of the spring season.

# TECHNICAL DATA - ENGINE

## TECHNICAL DATA - ENGINE 250/300 MX 2012

ENGINE	250	300
Type	2 stroke single-cylinder, liquid cooled	
Displacement	249.3 cm <sup>3</sup>	293.14 cm <sup>3</sup>
Cylinder bore and stroke	66.4x72	72x72
Compression	14.5:1	11.5:1
Fuel	unleaded fuel RON 95 mixed ratio 1:30 with oil	
Squish height	1.5/1.6 mm	1.6/1.7 mm
Piston height from cylinder upper that to the TDC	- 0.50 mm	- 0.55/0.60 mm
Crank shaft supports	2 ball bearings	
Connecting-rod big end	needle cage	
Connecting-rod small end	silver-plated needle cage	
Piston	forged light alloy	
Rings	1 ring	
Engine Lubrication	mixture 1:30 of unleaded fuel RON 95 and oil Bel Ray H1-R (or equivalent)	
Transmission oil	Bel Ray Gear Saver SAE 80W (or equivalent)	
Oil capacity	700 cc	
Primary transmission	straight toothing gears 19/57	
Clutch	multiple discs in oil bath	
Gearbox (with front engagement)	5 speed	
Gear ratios	1 <sup>a</sup> 15:27	
	2 <sup>a</sup> 17:25	
	3 <sup>a</sup> 19:23	
	4 <sup>a</sup> 21:21	
	5 <sup>a</sup> 23:20	
Ignition	Kokusan digital CDI with variable timing and 2 selectable maps	
Generator	12V-60W	
Regulator	Ducati Energia	
Spark plug	NGK BR 8EG	
Electrode gap	0,6-0.7 mm	
Cooling	liquid cooled 40 % antifreeze, 60 % water(up to -25°C), forced circulation with pump	
Coolant fluid capacity	1 litres	

**TECHNICAL DATA - ENGINE 250/300 END/SMR/SMM 2012**

<b>ENGINE</b>	<b>250</b>	<b>300</b>
Type	2 stroke single-cylinder, liquid cooled	
Displacement	249.3 cm <sup>3</sup>	293.14 cm <sup>3</sup>
Cylinder bore and stroke	66.4x72	72x72
Compression	14.5:1	11.5:1
Fuel	unleaded fuel RON 95 mixed ratio 1:30 with oil	
Squish height	1.5/1.6 mm	1.6/1.7 mm
Piston height from cylinder upper that to the TDC	- 0.50 mm	- 0.55/0.60 mm
Crank shaft supports	2 ball bearings	
Connecting-rod big end	needle cage	
Connecting-rod small end	silver-plated needle cage	
Piston	forged light alloy	
Rings	1 ring	
Engine Lubrication	mixture 1:30 of unleaded fuel RON 95 and oil Bel Ray H1-R (or equivalent)	
Transmission oil	Bel Ray Gear Saver SAE 80W (or equivalent)	
Oil capacity	700 cc	
Primary transmission	straight toothing gears 20/57	
Clutch	multiple discs in oil bath	
Gearbox (with front engagement)	5 speed	
Gear ratios	1 <sup>a</sup> 14 <sup>a</sup> :28	
	2 <sup>a</sup> 17:25	
	3 <sup>a</sup> 19:23	
	4 <sup>a</sup> 21:21	
	5 <sup>a</sup> 24:19	
Ignition	Kokusan digital CDI with variable timing and 2 selectable maps	
Generator	12V-60W	
Regulator	Ducati Energia	
Spark plug	NGK BR 8EG	
Electrode gap	0,6-0.7 mm	
Cooling	liquid cooled 40 % antifreeze, 60 % water(up to -25°C), forced circulation with pump	
Coolant fluid capacity	1 litres	

# CARBURETOR SETTINGS 2012

KEIHIN	250/300 END	250/300 MX	250/300 SMR/SMM				
Type	<b>PWK 38</b>	<b>PWK 38</b>	<b>PWK 38</b>				
Main Jet	180	185	185				
Slow Jet	45	50	55				
Jet needle	NOZE	NOZE	NOZI				
Clip position	3^ from top	3^ from top	3^ from top				
Throttle valve	7	7	7				
Slow air screw	1.5 urns	1.5 urns	1.5 urns				
Float height	16 mm	16 mm	20 mm				

# ENGINE TIGHTENING TORQUES

## 250/300 END/SMR/SMM ENGINE TIGHTENING TORQUES 2012

Crankcase Allen screws, transmission cover, clutch cover, ignition cover	M 6	12 Nm
Oil drain screw cap	M14x1.5	20 Nm
Oil filler screw cap	M14x1.5	20 Nm
Oil net filter screw cap	M 5	8 Nm
Oil cartridge filter cover Allen screws	M 5	8 Nm
Engine oil pump body screws	M6	12 Nm
Head-cylinder nuts	M 8	27 Nm
Head-cylinder flanged nuts	M 10	35 Nm
Water pump cover Allen screws	M 6	12 Nm
Water pump rotor	M 6	Loctite 243 + 15 Nm
Clutch hub nut	M18 x 1.5	Loctite 270 + 80 Nm
Clutch springs flanged screw	M 6	10 Nm
Mobile chain guide fastening flanged screws	M 6	Loctite 243 + 10 Nm
Ignition stator Allen screws	M 6	10 Nm
Ignition pickup fastening Allen screws	M 6	Loctite 243 + 10 Nm
Kickstart pedal screw	M 6	Loctite 243 + 25 Nm
Gear pedal Allen screw	M 6	Loctite 243 + 10 Nm
General screws/nuts	M 5	8 Nm
General screws/nuts	M 6	10 Nm
General screws/nuts	M 8	25 Nm

## TRANSMISSION OIL

Use only Bel Ray Gear Saver SAE 80W (or equivalent) and any quality oils that correspond to or exceed the quality standards of the API - SG or SH classes (indication on container).

### **WARNING**

A LEVEL THAT IS TOO LOW, LOW QUALITY OIL OR MAINTENANCE INTERVALS LONGER THAN ESTABLISHED, CAUSE SERIOUS DAMAGE TO THE ENGINE.



**TECHNICAL DATA - CYCLE PART 250/300 MX/END/SMR/SMM 2012**

	250/300 MX	250/300 END	250/300 SMR/SMM
Frame	Twin-spar high resistance aluminium alloy frame		
Front suspension	Marzocchi USD fork		
Rear/front suspension travel	300/315 mm		
Rear suspension	Aluminium swing arm (Single-arm on SMM), Progressive link, Sachs shock (Optional Ohilins and TM)		
Front disc brake	Ø 270 mm floating caliper	Ø 320 mm 4-pistons caliper	
Rear disc brake	Ø 245 mm floating caliper	Ø 245 mm SMR	Ø 220 mm SMM
Brake disc wear limit	mm. 0,4 below original thickness		
Front tyre	80/100-21"	90/90-21"	120/70-17" or 110/70-17"
"Rider only" air pressure	1,1 bar		
Rear tyre	110/90 - 19"	140/80 - 18"	150/60-17"
"Rider only" air pressure	1,1 bar		
Tank capacity	10 liters (including reserve 1 lt.)		
Final transmission	13/49	13/51	13/40
Chain	5/8 x 1/4"		
Optional rear sprockets	48,49,50,51,52		38,39, 40, 41, 42, 43, 44, 45, 46
Bulbs (only END/SMR/SMM)	Headlight (END/SMR)	HS1 12V 35/35W (SMM)	H3 12V 55W PK22s
	Front position light (END/SMR)	12V 5W W5W (SMM)	T10 12V 5W
	Rear position light/stop/number plate (END)	Led 12V 0.9W / 0.006W (SMR/SMM)	P21/5W 12V 21/5W BAY15d
	Direction indicator lamp (END/SMR/SMM)	R10W 12V 10W BA15S	

**TIGHTENING TORQUES 2012**
**250/300 MX/END**
**250/300 SMR/SMM**

	250/300 MX/END	250/300 SMR/SMM	
Front wheel axle flanged nut	M20x1,5	M20x1,5	40 Nm
Front brake caliper fastening screws	M8	M10	30Nm/40 Nm
Rear brake caliper fastening screws (SMM)		M8	25 Nm
Front brake disc fastening screws	M6 cl. 10,9	M6 cl. 10,9	15 Nm
Rear brake disc fastening screw	M6 cl. 10,9	M6 cl. 10,9	15 Nm
Rear brake disc fastening nut (SMM)		M8	25 Nm
Upper fork head fastening screws	M8	M8	20 Nm
Lower fork head fastening screws	M8	M8	20 Nm
Marzocchi fork leg fastening screws	M6	M6	12 Nm
Rear wheel axle flanged nut	M22x1,5	M22x1,5	80 Nm
Swing arm axle flanged nut	M16x1,5	M16x1,5	80 Nm
Handlebar caps fastening screws	M8	M8	20 Nm
Handlebar elastic support nut	M10	M10	35 Nm
Upper end shock nut	M10x1,25	M10x1,25	40 Nm
Lower end shock screws	M10x1,25	M10x1,25	35 Nm
Rear sprocket nuts	M8	M8	35 Nm
Rear brake pedal adjustment nut	M6	M6	15 Nm
Engine fastening screws	M10	M10	45 Nm
Rear wheel nut (SMM)		M50	185 Nm
Rear hub locking screws (SMM)	M12x1.25	M12x1.25	31 Nm
General frame screw	M6	M6	10 Nm
General frame nuts	M8	M8	25 Nm
	M10	M10	45 Nm
	M6	M6	15 Nm
	M8	M8	30 Nm
	M10	M10	50 Nm

# ALPHABETIC INDEX

	Page		Page
Adjustment of chain tension (all models except SMM) .....	43	Front brake BREMBO radial pump (SMR/SMM) .....	47
Adjustment of chain tension (SMM) .....	44	Front brake lever BREMBO radial pump (SMR/SMM) .....	10
<b>ADVICE AND GENERAL RECOMMENDATIONS FOR</b>		Front brake lever NISSIN pump .....	10
<b>COMMISSIONING THE MOTORCYCLE</b> .....	<b>21</b>	Front brake NISSIN pump (END/MX) .....	46
<b>ALPHABETIC INDEX</b> .....	<b>74</b>	Fuel .....	29
Basic calibration of the chassis on the basis of pilot weight .....	40	Fuel filler cap .....	14
Basic indications for TM disc brakes .....	45	Fuel tap .....	14
Basic indications regarding carburetor wear .....	63	Gear shift pedal .....	15
Battery (SMR and SMM) .....	54	Halogen light (END) .....	55
Battery charge .....	54	Halogen light (SMR) .....	55
Bike starting .....	26	Handlebar switch (SMR/SMM) .....	13
Bleeding hydraulic clutch .....	62	Hydraulic clutch BREMBO pump .....	61
Brake pedal .....	15	Idle speed adjustment command .....	15
Braking .....	28	If the engine is "flooded" .....	26
<b>CARBURETOR SETTINGS</b> .....	<b>72</b>	Ignition switch .....	14
Chain maintenance .....	44	Indications for first start-up .....	22
Chain wear .....	45	Inspection of the reed valve .....	66
Change transmission oil .....	66	<b>INSTRUCTIONS FOR USE</b> .....	<b>23</b>
Check adjustment of magnetic sensor for tachometer .....	53	Kickstart pedal .....	15
Check before every start-up .....	24	LED rear light (END) .....	58
Check chain tension .....	43	<b>MAINTENANCE AND LUBRICATION TABLE</b> .....	<b>31</b>
Check coolant level .....	60	Maps selection switch .....	13
Check front brake pads .....	47	Modification of rear brake pedal base position .....	49
Check fuel level (float height) .....	64	Notes on the carburettor .....	62
Check rear brake fluid level .....	49	<b>OPERATING CONTROLS</b> .....	<b>9</b>
Check rear brake pads .....	50	<b>POSITION OF SERIAL NUMBER</b> .....	<b>7</b>
Check spoke tension .....	52	<b>PRECAUTIONS FOR WINTER USE</b> .....	<b>69</b>
Check steering bearings and play adjustment .....	38	Rear light (SMR/SMM) .....	58
Check telescopic fork basic calibration .....	41	Rear suspension mechanical linkage .....	43
Check transmission oil level .....	65	Replacement of exhaust silencer packing material .....	60
Choke command (cold starter) .....	14	Replacement of fork springs .....	42
Ciclops headlight (SMM) .....	57	Replacement of front brake pads .....	48
<b>CLEANING</b> .....	<b>69</b>	Replacement of rear brake pads .....	50
Cleaning telescopic fork dust scraper .....	39	Running in instructions .....	22
Cleaning the air filter .....	61	Shifting gear, accelerating, slowing down .....	26
Clutch lever BREMBO pump .....	10	Shock absorber adjustment in compression .....	17
Cold engine start .....	25	Shock absorber adjustment in rebound .....	18
Combination switch (END) .....	12	Shock absorber calibration and spring check .....	40
Cooling .....	59	Side stand .....	16
Direction indicator lamp (END/SMR/SMM) .....	58	Side stand fixing for off-road routes .....	16
Disassembly and assembly of rear wheel (SMM) .....	52	Start-up after seasonal pause .....	69
Disassembly and assembly of the front wheel .....	50	Steering lock .....	19
Disassembly and assembly of the rear wheel (all except SMM) .....	51	Stopping and parking .....	28
Electronic digital tachometer (END) .....	11	<b>STORAGE</b> .....	<b>69</b>
Electronic digital tachometer (SMR/SMM) .....	11	<b>TECHNICAL DATA - ENGINE</b> .....	<b>70</b>
Emptying the carburetor float bowl .....	64	<b>TECHNICAL DATA-CYCLE PART</b> .....	<b>73</b>
Emptying, filling and bleeding of the cooling system .....	60	Telescopic fork vent screws .....	39
Engine number .....	8	Throttle cable command adjustment .....	62
Engine stop switch (MX) .....	12	Top-up rear brake fluid .....	49
<b>ENGINE TIGHTENING TORQUES</b> .....	<b>72</b>	Transmission oil .....	65
Establishing rear shock lowering in running order .....	41	<b>TROUBLESHOOTING</b> .....	<b>67</b>
Establishing rear shock static lowering .....	40	Tyres, tyre pressure .....	53
Fork adjustment in compression .....	16	Variation of rear shock spring preload .....	42
Fork adjustment in rebound .....	17	Variation of telescopic fork preload .....	41
<b>FRAME AND ENGINE MAINTENANCE</b> .....	<b>37</b>	<b>WIRING DIAGRAM</b> .....	<b>appendix</b>
Frame number .....	8		

# WIRING DIAGRAMS 2012

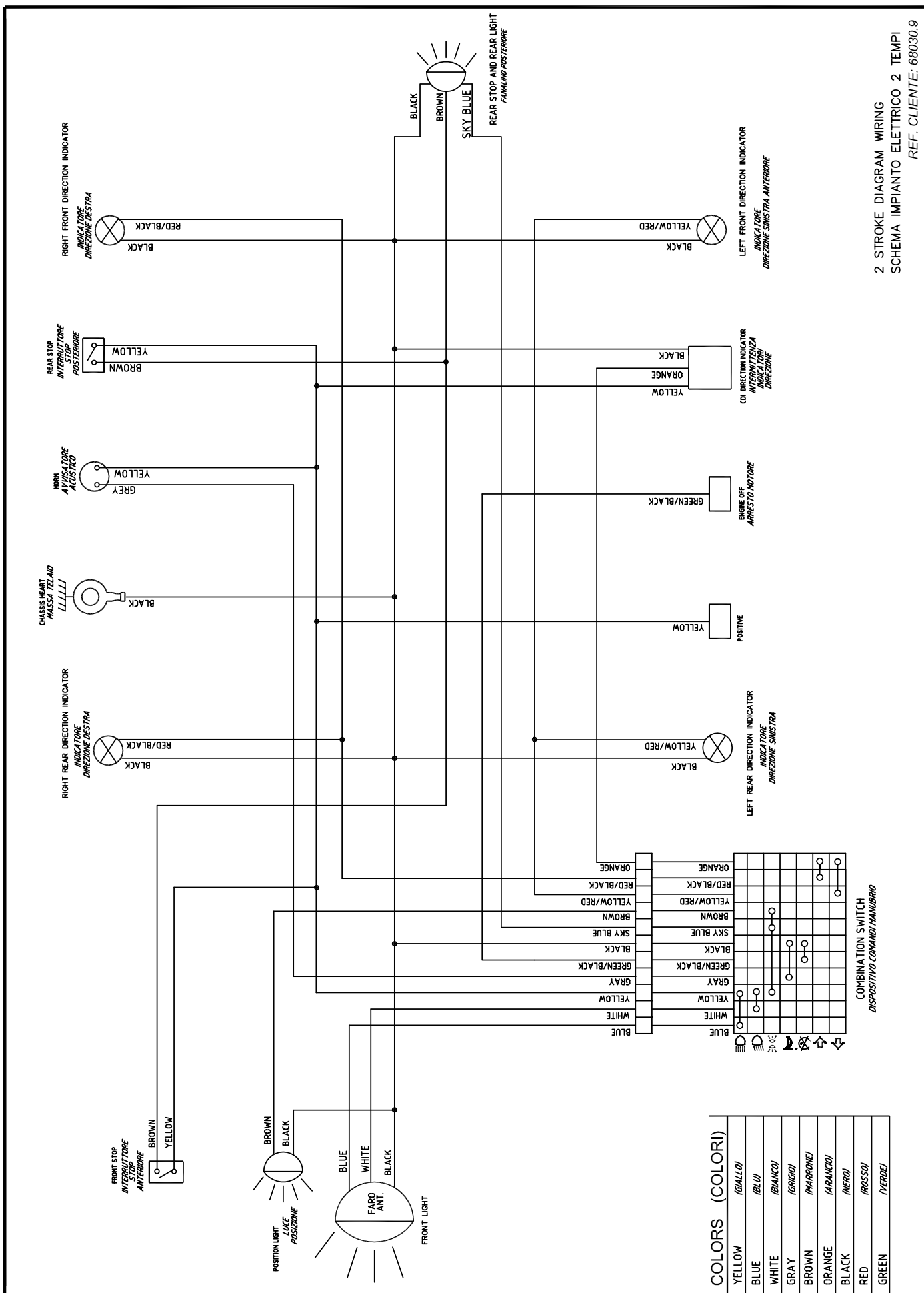

2 STROKE DIAGRAM WIRING  
SCHEMA IMPIANTO ELETTRICO 2 TEMPI  
REF. CLIENTE: 68030.9



© TM Racing S.p.A.

Via Fano, 6 - 61122 Pesaro - Italy

Ph. +39 0721 25113 - Fax +39 0721 401808

Published and printed by SERIART - [www.seriart.com](http://www.seriart.com)